

HIFI FILTER[®]

VOTRE PARTENAIRE EN FILTRATION
YOUR PARTNER IN FILTRATION
IHR FILTRATION PARTNER

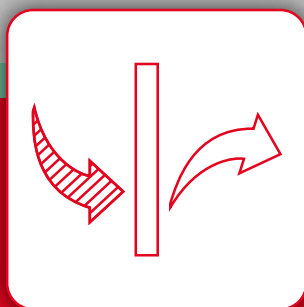

AÉRAULIQUE
AEROLICS
KLIMA- UND LÜFTUNGSANLAGE

www.hifi-filter.com

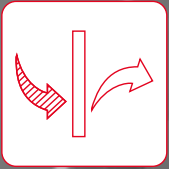

SOMMAIRE

CONTENTS

INHALTSVERZEICHNIS

ABC...

Codification
Codification
Legende

1 - 6

G

Préfiltre - Filtration gravimétrique
Prefilter - *Gravimetric filtration*
Vorfilter - *Gravimetrische Filtrierung*

7 - 28

F

Filtres fins - Filtration opacimétrique
Fine filter - *Opacimetric filtration*
Feinstaubfilter - *Opazimetrische Filtrierung*

29 - 48

H

Filtres absolus - Filtration absolue HEPA
Absolute filters - *Absolute HEPA filtration*
Schwebstoff-filter - *HEPA Schwebstofffilter*

49 - 64

CA
CAG

Adsorption - Filtres charbon actif
Adsorption - *Carbon filters*
Adsorbierung - *Aktivkohle-Filteractive*

65 - 68









Recommandations générales
General advices
Allgemeine Hinweise

Trucs et astuces
Tricks and clever bits
Tipps

Nos catalogues
Our catalogues
Unsere Kataloge

Conditions générales de vente
General terms of sales
Allgemeine Geschäftsbedingungen

69 - 80

	 CODIFICATION N° HIFI	 HIFI N° CODIFICATION	 HIFI N° LEGENDE	 CODIFICACIÓN N° HIFI	 CODIFICAZIONE N° HIFI	 CODIFICACIÓN N° HIFI	 KODYFIKACJA N° HIFI
ASP... ASR...	Filtere dépoussiérage	Dusting filter	Entstaubungsfilter	Filtero de desempolvamiento	Filtero depolverazione	Filteru desprăfuire	Filter odpylający
BE...	Filtere à essence	Petrol/gasoline filter	Benzinfilter	Filtero de gasolina	Filtero da benzina	Filteru benzină	Filter benzyny
CL...	Cle à filtre	Filter wrench	Filterschlüssel	Llave para filtro	Chiave per filtro	Cheie filteru	Klucz do filtra
CR...	Filtere Hydraulique retour	Return hydraulic filter	Rücklauf-Hydraulikfilter	Filtero hidráulico de retorno	Filtero idraulico di ritorno	Filteru hidraulic retur	Filter hydrauliczny powrotny
EAP...	Filtere Piscine	Swimming pool filter	Schwimmbadfilter	Filtero de piscina	Filtero per piscina	Filteru apă	Filter basenowy
EL...	Filtere électro-érosion	Spark erosion filter	Elektroerosionsfilter	Filtero de electro erosión	Filtero ellettroerosione	Filteru electro-eroziune	Filter do elektroerozji
EZ...	Filtere pour liquide	Filter for liquids	Filter für flüssigkeit	Filtero para líquidos	Filtero per liquidi	Filteru de lichide	Filter do płynów
FS...	Filtere Aération Réservoir	Tank vent air breather	Tankentlüftungsfilter	Filtero de ventilación de depósito	Filtero di aerazione per serbatoio	Filteru aerisire rezervor	Filter przewietrzania zbiornika
FT...	Filtere à gasoil/Diesel	Diesel fuel filter	Kraftstofffilter	Filtero de gasoil/Diesel	Filtero da gasolio	Filteru motorină/Diesel	Filter do ropy/Diesel
JO...	Joint plat	Flat gasket	Flachdichtung	Junta plana	Guarnizione piatta	Gamitură plată	Uszczelka płaska
JR...	Joint o-ring	O-ring gasket	O-Ring-Dichtung	Junta oring	Guarnizione o-ring	Gamitură o-ring	Uszczelka o-ring
KA...	Kit filtre à air	Air filter kit	Luffilter Kit	Kit filtro de aire	Kit filtro a aria	Kit filteru de aer	Filter powietrza-zestaw
KAO...	Kit filtre aération moteur	Engine breather filter kit	Motorentlüftungsfilter Kit	Kit filtro aireación motor	Kit filtro sfato motore	Kit filteru ventilatie motor	Filter odmy silnika-zestaw
KH...	Kit filtre hydraulique	Hydraulic filter kit	Hydraulikfilter Kit	Kit filtro hidráulico	Kit filtro idraulico	Kit filteru hidraulic	Filter hydrauliczny-zestaw
KN...	Kit filtre à gasoil	Fuel filter kit	Dieselfilter Kit	Kit filtro de gasoil	Kit filtro a gasolio	Kit filteru de motorina	Filter paliwa-zestaw
KO...	Kit filtre à huile	Oil filter kit	Oelfilter Kit	Kit filtro de aceite	Kit filtro a olio	Kit filteru de ulei	Filter oleju-zestaw
MO...	Préfiltre et filtre à gasoil complet	Complete Diesel fuel prefilter and filter	Kraftstofffilter: Vor- und Kompletfilter	Pre filtro y filtro de gasoil completo	Prefiltro e filtro da gasolio completo	Prefiltru și filteru motorină complet	Filter wstępny i filter kompletny do ropy
OA... OD... OE... OS... OT... OV...	Séparateur air/huile	Air / Oil separator	Luft- / Öl-Abscheider	Separator aire/aceite	Separatore ad aria	Separator aer/ulei	Separator powietrza/olej

PL...	Poche liquide	Liquid bag filter	Filterbeutel zur Flüssigkeitsfiltration	Bolsa para liquido	Sacca a liquidi	Buzunar lichid	Filtry workowe do płynów
SA...	Filtre à air	Air filter	Lufffilter	Filtro de aire	Filtro ad aria	Filturu aer	Filtru aer
SAB... SAC... SAD...	Filtre à air série Duralite	Duralite air filter	Duralite Lufffilter	Filtro de aire serie Duralite	Filtro ad aria serie Duralite	Filturu aer serie Duralite	Filtru aer serie Duralite
SAO...	Filtre aération moteur	Crankcase ventilation	Motorentlüftungsfiler	Filtro de ventilación motor	Filtro aerazione motore	Filturu aerisire motor	Filtru przewietrzania silnika
SAM...	Masse filtrante	Filtering mass	Filtermasse	Masa filtrante	Masa filtrante	Masa de filtrare	Materiál filtracyjny
SC...	Filtre cabine ou habitacle	Cabin filter	Innenraumfilter	Filtro de cabina o habitaculo	Filtro di abitacolo	Filturu cabină sau habitaculu	Filtru kabinowy
SC.CAG	Filtre habitacle charbon actif granulé	Active carbon cabin filter	Kabinen-Aktivkohlefilter	Filtro de cabina de carbón activo	Filtro da abitacolo in carbone attivo	Filturu polen carbon activ	Filtru kabinowy z węglem aktywnym
SD...	Filtre à urée	Urea filter	Harnstofffilter	Filtro de urea	Filtro urea	Filturu aditiv combustibil	Filtru mocznika
SF...	Filtre à air métallique	Metalic air filter	Metallischer Lufffilter	Filtro de aire metálico	Filtro ad aria in metallo	Filturu aer metallic	Filtru powietrza metalowy
SG...	Filtre à gaz	Gas filter	Gasfilter	Filtro de gas	Filtro a gas	Filturu gaz	Filtru gazu
SH...	Filtre hydraulique	Hydraulic filter	Hydraulikfilter	Filtre hidráulico	Filtro idraulico	Filturu hidraulic	Filtru hydrauliczny
SI...	Sécheur d'air	Air dryer	Lufttrockner	Secador de aire	asciugatura d'aria	Uscător de aer	Osuszacz powietrza
SN...	Filtre à gasoil/Diesel	Diesel fuel filter	Kraftstofffilter	Filtro de gasoil/Diesel	filtru da gasolio	Filturu motorină/Diesel	Filtru do ropy/Diesel
SO...	Filtre à huile	Oil filter	Ölfilter	Filtro de aceite	Filtro da olio	Filturu ulei	Filtru oleju
T...	Filtre à huile	Oil filter	Ölfilter	Filtro de aceite	Filtro da olio	Filturu ulei	Filtru oleju
TB...	Dessiccateurs de freins	Brakes desiccators	Lufttrockner-Patrone	Secador de frenos	Essicatori freni	Uscator frana	Osuszacze układu hamulców pneumatycznych
TCO...	Bouchon de réservoir	Tank cover	Tank-Verschluss	Tapa de depósito	Tappo per serbatoio	Buşon rezervor	Korek wlewu oleju
WE...	Filtre eau moteur	Engine water cooling filter	Motowasserfilter	Filtro de agua motor	Filtro da acqua per il motore	Filturu lichid răcire	Filtru wody silnika
Y...	Accessoire pour filtre Racor	Accessories for Racor filter	Zubehör für Racor-Filter	Accesorio para filtro RACOR	Accessori per filtro RACOR	Accesorii pentru filtru RACOR	Aksesorii do separatora RACOR

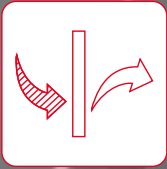

BON À SAVOIR GOOD TO KNOW GUT ZU WISSEN

How Big is a Micron?

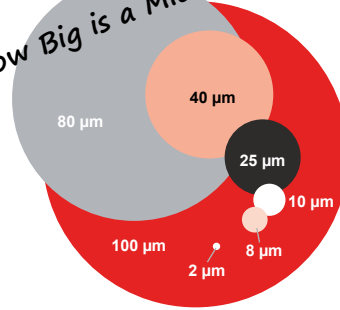

100 µm	Grain sel de table	Grain of table salt	Speisesalz Korn
80 µm	Cheveu humain	Human hair	Menschenhaar
40 µm	Seuil limite de visibilité	Lower limit of visibility	Unterste Sichtbare grenze
25 µm	Globules blancs	White blood cell	Weisse Blutzellen
10 µm	Talc	Talcum powder	Talkumpuder
8 µm	Globules rouges	Red blood cell	Rote Blutzellen
2 µm	Bactérie	Bacteria	Bakterien

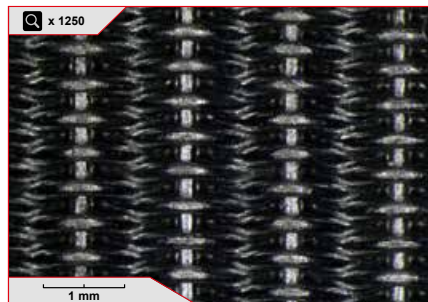

Toile métallique 90 µm
Wire mesh 90 µm
Metallgewebe 90 µm



Cellulose 25 µm
Zellulose 25 µm

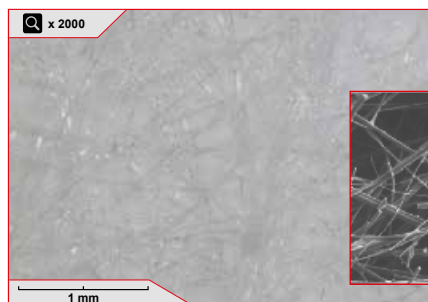

Fibre de verre 10 µm
Fiber glass 10 µm
Glasfiber 10 µm

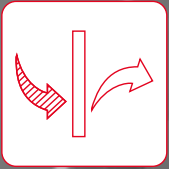

GAMME MOBILE

MOBILE PRODUCTS

PRODUKTE FÜR MOBILE GERÄTE

**Vous nous connaissez pour le matériel INDUSTRIE...
Cependant, avez-vous pensé à notre gamme MOBILE ?**

 Vous avez peut-être un ou plusieurs véhicules à moteur, 4 ou 2 roues, un bateau, du matériel d'entretien d'espaces verts, de manutention, de travaux publics, agricole...
Nous pouvons vous apporter toutes les solutions complémentaires à vos approvisionnements en filtration. N'hésitez pas à nous consulter.

**You know about us because of our INDUSTRY range of products...
But have you ever thought about our MOBILE products?**

 We also offer a full range of supplementary filtration supplies for your 2- or 4-wheeled motor vehicle, boat, green space or public works maintenance or agricultural equipment. Please do not hesitate to contact us for further information.

**Sie kennen uns wegen unserer INDUSTRIE-produkte...
Haben Sie jedoch schon an unsere Produkte für MOBILE Geräte gedacht?**

 Sie besitzen vielleicht ein oder mehrere Motorfahrzeuge, 4 oder 2 Räder, ein Schiff, Geräte zur Pflege von Grünflächen, zur Beförderung, für öffentliche Bauarbeiten oder für die Landwirtschaft...
Wir bieten Ihnen alle für Ihre Filterausrüstung erforderlichen Zusatzlösungen. Zögern Sie nicht, sich an uns zu wenden.



Travaux publics
Construction equipment
Hoch- und Tiefbau



Automobile
Passenger cars
PKW



Marine
Marine
Schifffahrt



Manutention
Handling equipment
Gabelstapler und Hebetchnik



Agricole
Agriculture
Landwirtschaft



Espaces verts
Golf & Parks
Golf und Gartentechnik



Poids lourds / Bus
Trucks / Buses
LKW / Busse



Remontées mécaniques
Ski lifts
Skipistenbearbeitung



Motos - Quads
Motorcycles - ATV
Motorräder - Quads

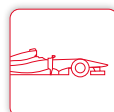

Hautes performances
High performance
Hochleistung



Vous souhaitez en savoir plus, nos équipes sont à votre écoute.
If you would like to know more, please contact one of our teams.
Für weitere Informationen wenden Sie sich bitte an unsere Mitarbeiter.

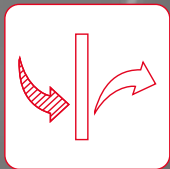

CLASSIFICATION CLASSIFICATION KLASSIFIKATION

	EN 779 : 2012	EUROVENT 4/5	ASHRAE 52.2	Efficacité / Efficiency / Leistung		
				Am (@ 250 Pa) %	Emoyen (p=0.4 µm @ 450 Pa) %	MTE %
Grossier Coarse Gross	G1	EU1	MERV 1-3	50 < Am < 65	-	-
	G2	EU2	MERV 4-5	65 < Am < 80	-	-
	G3	EU3	MERV 6-7	80 < Am < 90	-	-
	G4	EU4	MERV 8-9	Am ≥ 90	-	-
Moyens Medium Mittel	M5	EU5	MERV 10-9	-	40 ≤ Em < 60	-
	M6	EU6	MERV 11-12	-	60 < Em < 80	-
Fin Fine Fein	F7	EU7	MERV 13-14	-	80 < Em < 90	35
	F8	EU8	MERV 15	-	90 < Em < 95	55
	F9	EU9	MERV 16	-	Em ≥ 95	70

	EN 1822 : 2009	EUROVENT 4/5	Efficacité / Efficiency / Leistung	
			MPPS %	DOP (@ 0.3 µm) %
EPA	E10	EU10	> 85	> 85
	E11	EU11	> 95	> 95
	E12	EU12	> 99.5	> 99.5
HEPA	H13	EU13	> 99.95	> 99.95
	H14	EU14	> 99.995	> 99.995
ULPA	U15	EU15	> 99.9999	> 99.9999
	U16	EU16	> 99.99999	> 99.99999
	U17	EU17	> 99.999999	> 99.999999

Am : Arrestance moyenne
MTE : Minimum Test Efficiency
MPPS : Most Penetrating Particle Size

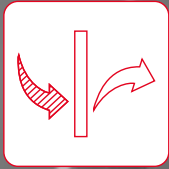

SOMMAIRE



CONTENTS



INHALTSVERZEICHNIS

ABC...

Codification

Codification
Legende

1 - 6

G

Préfiltre - Filtration gravimétrique

Prefilter - Gravimetric filtration
Vorfilter - Gravimetrische Filtrierung

7 - 28

F

Filtres fins - Filtration opacimétrique

Fine filter - Opacimetric filtration
Feinstaubfilter - Opazimetrische Filtrierung

29 - 48

H

Filtres absolus - Filtration absolue HEPA

Absolute filters - Absolute HEPA filtration
Schwebstoff-filter - HEPA Schwebstofffilter

49 - 64

CA
CAG

Adsorption - Filtres charbon actif

Adsorption - Carbon filters
Adsorbierung - Aktivkohle-Filteractive

65 - 68



Recommandations générales

General advices
Allgemeine Hinweise

Trucs et astuces

Tricks and clever bits
Tipps

Nos catalogues

Our catalogues
Unsere Kataloge

Conditions générales de vente

General terms of sales
Allgemeine Geschäftsbedingungen

69 - 80



NATTES FILTRANTES POLYESTER - SYNTHÉTIQUE



FILTER MATS POLYESTER - SYNTHETIC



FILTERMATTEN SYNTHETISCH - POLYESTER

G2 - G3 - G4



N° Hifi	Classe filtration Filterklassen		Efficacité gravimétrique Gravimetry efficiency Gravimetrie Effizienz Am	Dimensions Abmessungen		Progressif Progressive Progressiv	Poids Weight Gewicht gr/m ²
				Long. x Larg. Lenght x Width Breite x Länge m	Épais. Thickness Dicke mm		
N 40M02000 SA	G2	EN 779	74 %	40 x 2	5	non / no / nein	100
N 20M02000 SB	G3	EN 779	82 %	20 x 2	10	non / no / nein	150
N 20M02000 SL	G3	EN 779	81 %	20 x 2	18 ± 2	oui / yes / ja	190
N 40M02000 SP	G4	EN 779	83 %	40 x 2	12 ± 2	oui / yes / ja	152
N 20M02000 SD	G4	EN 779	90 %	20 x 2	20 ± 2	non / no / nein	200
N 20M02000 SN	G4	EN 779	90 %	20 x 2	20 ± 2	oui / yes / ja	214
N 20M02000 SE	G4	EN 779	94 %	20 x 2	20 ± 2	oui / yes / ja	263
N 20M02000 SQ	G4	EN 779	93 %	20 x 2	50 ± 2	oui / yes / ja	405

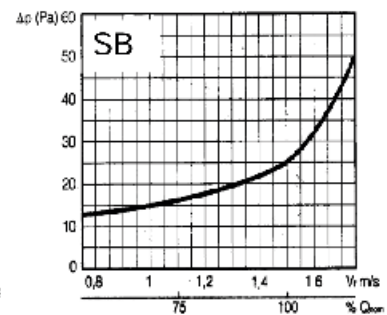
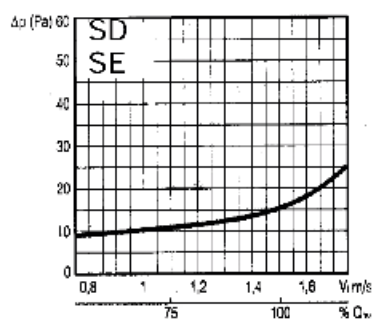
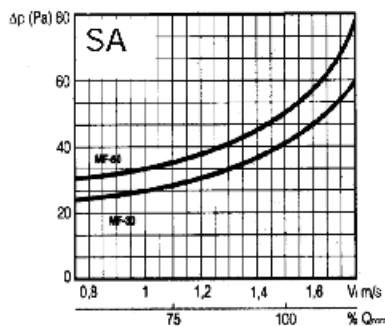

Autres modèles et découpes sur demande.
Other models and cuts on request.
Andere Modelle und Zuschnitt auf Anfrage.



NATTES FILTRANTES POUR CABINES DE PEINTURE
FILTER MATS FOR PAINT BOOTHS
FILTERMATTEN FÜR SPRITZMALEREI-KABINEN

G2 - G3 - G4 - M5

Applications (Entrée d'air)
Applications (Air inlet)
Anwendungen (Lufteintritt)

Serie SH, SI (Polyester)

Température (Polyester)
Temperature (Polyester)
Temperatur (Polyester)

+ 110°C max.

Applications (Extraction)
Applications (Extraction)
Anwendungen (Extraktion)

Série VA-VI
 (Fibre de verre / Fiberglass
 Glasfaser)

Température (Fibre de verre)
Temperature (Fiberglass)
Temperatur (Glasfaser)

+ 120°C max.

Résistant à l'humidité
 Moisture resistant
 Wasserbeständig



N° Hifi	Media	ΔP Initiale ΔP Initial ΔP Anfang Pa	ΔP Finale ΔP Final ΔP Ende Pa	Classe Class Klasse EN779	Efficacité gravimétrique Gravimetry efficiency Gravimetrie Effizienz	Dimensions / Abmessungen		
						Long. Length Breite m	Larg. Width Länge m	Épaisseur Thickness Dicke mm
N 20M02000 VA	Fibre de verre Fiberglass Glasfaser	20	250**	G2	80%	20	2	30
N 20M02000 VI	Fibre de verre Fiberglass Glasfaser	25	250**	G2	83%	20	2	60
N 20M02000 VJ	Fibre de verre Fiberglass Glasfaser	35	250**	G3	85%	20	2	75
N 20M02000 VH	Fibre de verre Fiberglass Glasfaser	40	250**	G4	91%	20	2	100
N 20M02000 SI	Polyester imprégné* Impregnated polyester* Polyester imprägniert*	45	450**	M5	98%	20	2	22
N 20M02000 SH	Polyester sec* Dry polyester* Polyester trocken*	20	450**	M5	97%	20	2	18

* Avec grille de protection / With protection grid / Mit Schutzgitter

** Recommandé / Recommended / Empfohlen

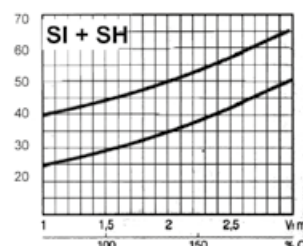
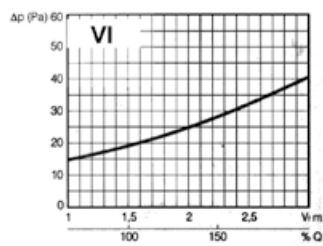
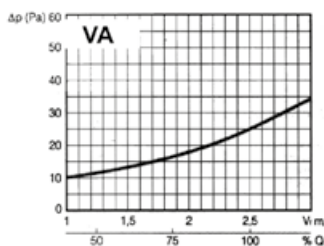

Autres modèles et découpes sur demande
 Other models and cuts on request
 Andere Modelle und Abschnitte auf Anfrage



FILTRES À INERTIE POUR CABINES DE PEINTURE

INERTIA FILTERS FOR SPRAY BOOTH

SPRITZMALEREI-KABINEN BEHARRUNGSKRAFTFILTER

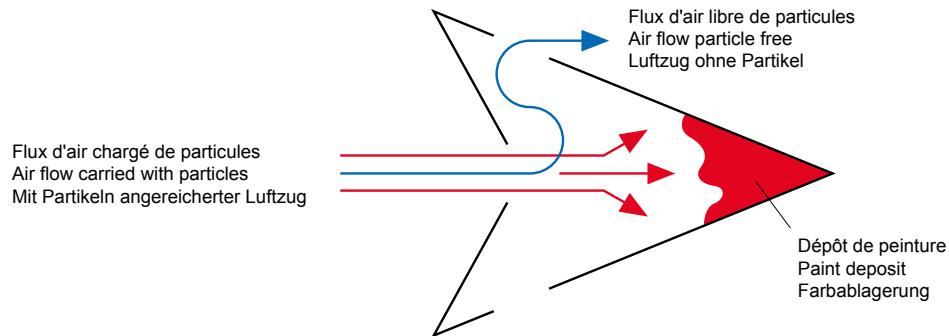

Filterer n'est pas nécessairement l'interception de particules véhiculées par un flux d'air à l'aide d'une succession de tamis aux mailles de plus en plus fines. Les filtres en carton plissé fonctionnent selon un autre principe : la séparation par inertie. Le flux d'air chargé de particules qui transite à travers le filtre, est soumis à des changements brutaux de direction. Les particules, de par leur masse, sont éjectées hors du flux d'air lors des changements de direction.



Absence de migration :

Lorsque la particule de peinture est déposée dans la poche de rétention, elle se trouve dans un "cul-de-sac" en dehors du flux d'air, ce flux d'air ne peut donc plus l'entraîner ni la faire "migrer" au travers du filtre.

Durée de vie plus longue :

Les poches de rétention confèrent aux filtres une capacité de charge 3 à 5 fois supérieure à un filtre à mailles. Les passages de l'air restent libres bien que le filtre se charge de particules. Dans le cas d'un filtre à mailles, les particules vont généralement créer un dépôt superficiel qui va rapidement colmater la surface du filtre. Le filtre ne sera pas chargé en profondeur, limitant sa capacité de charge. Le filtre par inertie, lui, ne se colmatera que lorsque les poches de rétention seront entièrement remplies de peinture.

Filtering is not necessarily the interception of carried particles by an air flow through a succession of meshes thinner and thinner. The pleated carton filters operates an other way : the inertial separation. The air flow loaded with particles and transiting through the filter, is going, through sudden brutal direction changes. Due to their mass, the particles are ejected out of the air flow when it changes direction.



Migration lack :

When the paint particle is deposited in the retention bag, it is contained in a dead end out of air flow. Therefore this air flow cannot drag the particle along trough the filter.

Longer life span :

The retention bags give a load capacity 3 to 5 times higher than a mesh filter. The air way stays free even though the filter is loaded with particles. With a mesh filter the particles will generally create a superficial deposit that will rapidly clog the filter surface up. Therefore the filter will not be loaded deeply and its capacity will be limited. At the contrary, the inertia filter, will only clog up when the retention bags are completely filled up with paint.

Filtern bedeutet nicht nur das Abfangen von mobilen Farbpartikeln durch einen Luftstrom mit Hilfe einer Folge von immer feiner werdenden Maschensieben.

Die Filter aus plissiertem Karton funktionieren nach einem anderen Prinzip : die Abscheidungs-Beharrungskraft.

Beim Durchgang durch den Filter ist der mit Farbpartikeln angereicherte Luftstrom mehrfach krassen Richtungsänderungen ausgesetzt. Dabei werden die Partikel, durch ihre Masse, aus dem Luftstrom ausgestossen.



Migrationsabwesenheit :

Wenn sich die Farbpartikel in den Zurückbehaltungs-Taschen festgesetzt haben, befinden sie sich in einer Sackgasse, ausserhalb des Luftdurchflusses; somit wandern die Partikel nicht durch den Filter.

Laengere Lebenszeit :

Die Zurückbehaltungs-Taschen geben Filter eine 2 bis 5 mal höhere Belastungsfähigkeit als einem Maschenfilter. Die Luftübergänge bleiben frei, obwohl der Filter mit Partikeln beladen ist. Im Falle eines Maschenfilters bilden die Partikel im allgemeinen ein Depot auf der Oberfläche, und der Filter wird rasch verstopft. Der Filter wird nicht tief belastet, seine Nutzbelastung wird so begrenzt. Der Beharrungskraftfilter wird nur verstopft sein, wenn die Zurückbehaltungs-Taschen völlig mit Farbe gefüllt werden.



FILTRES À INERTIE POUR CABINES DE PEINTURE
INERTIA FILTERS FOR SPRAY BOOTH
SPRITZMALEREI-KABINEN BEHARRUNGSKRAFTFILTER

STANDARD

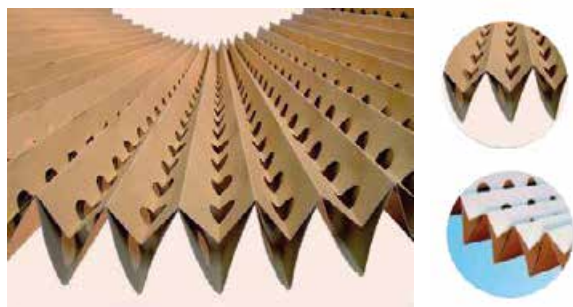

Épaisseur / Thickness / Dicke	60 mm
Vitesse de l'air recommandée Recommended air speed Empfohlene Luftgeschwindigkeit	0.25 à 1m/s
ΔP initiale / Initial ΔP / Anfangs-ΔP	12 Pa @ 0.5 m/s
ΔP final recommended	128 - 150 Pa
Capacité de rétention (charge) * Holding capacity (load) * Aufnahmekapazität (Last) *	16 kg/m ²
Éfficacité de filtration (poids) Filtration efficiency (weight) Abscheidegrad (Gewicht)	→ 98.1 % max.
Dimensions / Abmessungen	75 cm x 13.5 m (10 m ²) 90 cm x 11.2 m (10 m ²) 100 cm x 10 m (10 m ²)
Mise en place standard - nombre de plis au mètre Standard mounting - Pleats per meter Standardmontage - Faltenanzahl pro Meter	26
Overspray à haut extrait sec, hydro - Nombre de plis au mètre High solids coatings - Pleats per meter High-Solid-Lacken - Faltenanzahl pro Meter	26 → 45

* Variable suivant le type d'overspray (peinture, vernis, ...)
 * Depending on overspray used (Paint, Varnish, etc...)
 * Gemäss der angewendeten overspray (Farbe, Firnis, etc...)

Type	N° Hifi		
	Largeur / Width / Breite		
	75 cm	90 cm	100 cm
Brun / Brow / Braun	N 13M50750 CC	N 11M20900 CC	N 10M01000 CC
Blanc / White / Weiss	N 13M50750 CB	N 11M20900 CB	N 10M01000 CB
Ignifugé * / Fire-retardant * / Feuerfest *	N 13M50750 CD	N 11M20900 CD	N 10M01000 CD

* Classement au feu : M2
 * Fire class : M2
 * Brandklasse : M2

 Autres dimensions sur demande.
 Other dimensions on request.
 Andere Abmessungen auf Anfrage.



FILTRES À INERTIE POUR CABINES DE PEINTURE
INERTIA FILTERS FOR SPRAY BOOTH
SPRITZMALEREI-KABINEN BEHARRUNGSKRAFTFILTER

STANDARD + FIBER GLASS

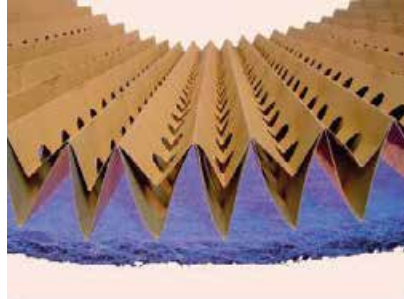

Épaisseur / Thickness / Dicke	55 mm + 15 mm fiber glass
Vitesse de l'air recommandée Recommended air speed Empfohlene Luftgeschwindigkeit	0.5 à 1m/s
ΔP initiale / Initial ΔP / Anfangs-ΔP	14 Pa @ 0.5 m/s
ΔP final recommended	155 Pa
Capacité de rétention (charge) * Holding capacity (load) * Aufnahmekapazität (Last) *	18 kg/m ²
Éfficacité de filtration (poids) Filtration efficiency (weight) Abscheidegrad (Gewicht)	→ 99.3 % max.
Dimensions / Abmessungen	75 cm x 10.8 m (8 m ²) 90 cm x 8.9 m (8 m ²) 100 cm x 8 m (8 m ²)
Mise en place standard - nombre de plis au mètre Standard mounting - Pleats per meter Standardmontage - Faltenanzahl pro Meter	25
Overspray à haut extrait sec, hydro - Nombre de plis au mètre High solids coatings - Pleats per meter High-Solid-Lacken - Faltenanzahl pro Meter	25 → 30

- * Variable suivant le type d'overspray (peinture, vernis, ...)
- * Depending on overspray used (Paint, Varnish, etc...)
- * Gemäss der angewendeten overspray (Farbe, Firnis, etc...)

N° Hifi			
Type	Largeur / Width / Breite		
	75 cm	90 cm	100 cm
Brun / Brow / Braun	N 10M80750 CX	N 89000900 CX	N 80001000 CX
Blanc / White / Weiss	N 10M80750 CXB	N 89000900 CXB	N 80001000 CXB



Autres dimensions sur demande.
 Other dimensions on request.
 Andere Abmessungen auf Anfrage.



FILTRES À INERTIE POUR CABINES DE PEINTURE
INERTIA FILTERS FOR SPRAY BOOTH
SPRITZMALEREI-KABINEN BEHARRUNGSKRAFTFILTER

STANDARD + SYNTHETIC



Épaisseur / Thickness / Dicke	70 mm
Vitesse de l'air recommandée Recommended air speed Empfohlene Luftgeschwindigkeit	0.25 à 1m/s
ΔP initiale / Initial ΔP / Anfangs-ΔP	12 Pa @ 0.5 m/s
ΔP final recommended	128 - 150 Pa
Capacité de rétention (charge) * Holding capacity (load) * Aufnahmekapazität (Last) *	20 kg/m ²
Éfficacité de filtration (poids) Filtration efficiency (weight) Abscheidegrad (Gewicht)	→ 99.2 % max.
Dimensions / Abmessungen	75 cm x 10.8 m (8 m ²) 90 cm x 9.2 m (8 m ²) 100 cm x 8 m (8 m ²)
Mise en place standard - nombre de plis au mètre Standard mounting - Pleats per meter Standardmontage - Faltenanzahl pro Meter	26
Overspray à haut extrait sec, hydro - Nombre de plis au mètre High solids coatings - Pleats per meter High-Solid-Lacken - Faltenanzahl pro Meter	26 → 32

- * Variable suivant le type d'overspray (peinture, vernis, ...)
- * Depending on overspray used (Paint, Varnish, etc...)
- * Gemäss der angewendeten overspray (Farbe, Firnis, etc...)

Type	N° Hifi		
	Largeur / Width / Breite		
	75 cm	90 cm	100 cm
Brun / Brow / Braun	N 10M80750 CH	N 92000900 CH	N 80001000 CH
Blanc / White / Weiss	N 10M80750 CJ	N 92000900 CJ	N 80001000 CJ
Ignifugé * / Fire-retardant * / Feuerfest *	N 10M80750 CI	N 92000900 CI	N 80001000 CI

- * Classement au feu : M2
- * Fire class : M2
- * Brandklasse : M2



Autres dimensions sur demande.
 Other dimensions on request.
 Andere Abmessungen auf Anfrage.



FILTRES MOUSSE POLYURETHANE
POLYURETHAN FILTRATION FOAMS
POLYURETHAN SCHAUMSTOFFFILTER

Non traitées, ces mousses sont employées pour filtrer les liquides (mousse polyéthère) et les gaz (mousse polyester) ou, sous une forme plus travaillée, on les utilise en tant que support. Température de travail de -40° à +100° C.

They are used untreated as liquid and gas filters, or in further refined form as filtration or carrier media. Working temperature -40° to +100° C.

Sie werden unbehandelt als Flüssigkeits- und Gasfilter oder in einer edleren Form, als Filter oder Trägermedium eingesetzt. Arbeitstemperatur -40° bis +100°C.

Grade Rank Reihe	Épaisseur Thickness Dicke mm	N° Hifi 2000 x 1000 mm	PPI	Résistance à la traction Tensile strength Zugfestigkeit kPa	Perméabilité Permeability Durchlässigkeit L/ (m ² x s)
10	5	N 20001000 PA	8 → 13	100	7500
	10	N 20001000 PB			
	20	N 20001000 PC			
20	5	N 20001000 PE	16 → 23	120	5300
	10	N 20001000 PF			
	20	N 20001000 PG			
30	5	N 20001000 PI	27 → 34	150	3850
	10	N 20001000 PJ			
	20	N 20001000 PK			
45	5	N 20001000 PM	41 → 49	180	2850
	10	N 20001000 PN			
	20	N 20001000 PO			
60	5	N 20001000 PQ	57 → 70	200	1850
	10	N 20001000 PR			
	20	N 20001000 PS			
80	5	N 20001000 PU	75 → 90	250	1217
	10	N 20001000 PV			
	20	N 20001000 PW			

PPI (PA ; PB ; PC)



PPI (PE ; PF ; PG)



PPI (PI ; PJ ; PK)



PPI (PM ; PN ; PO)



PPI (PQ ; PR ; PS)



PPI (PU ; PV ; PW)



Autres dimensions et traitements spécifiques sur demande.
 Other dimensions and specific treatments on request.
 Andere Dimensionen und spezifische Behandlung auf Anfrage.



VENTILO CONVECTEURS
FAN COILS FILTERS
KLIMAAANLAGEN FILTER

G3

Cadre / Frame / Rahmen	Fil galvanisé (Ø 4 mm) / Galvanized Wire (Ø 4 mm) / Verzinktem Draht (Ø 4 mm)
Média / Media / Media	Polyester
Classe de filtration / Class of filtration / Filterklasse	G3 (EN 779 : 2012)
Température / Temperature / Temperatur	70°C max.
Humidité relative / Relative humidity / Luftfeuchtigkeit	90 % max.
ΔP final recommended	250 Pa



N° Hifi	Dimensions / Abmessungen mm		Débit Flow Strom m³/h	ΔP initiale Initial ΔP Anfangs-ΔP Pa	Surface filtrante Filtering surface Filterierende Fläche m²
	L	I			
G3					
NN 4438 S	335	270	640	50	0.09
NN 2683 S	350	250	640	50	0.09
NN 3781 S	390	195	720	50	0.10
NN 2111 S	415	237	720	50	0.10
NN 3780 S	432	60	210	50	0.03
NN 2096 S	435	150	500	50	0.07
NN 2116 S	445	365	1150	50	0.16
NN 2690 S	465	365	1580	50	0.22
NN 2119 S	465	465	1580	50	0.22
NN 2112 S	492	237	860	50	0.12
NN 2115 S	492	340	1220	50	0.17
NN 2118 S	492	440	1580	50	0.22
NN 2120 S	565	465	1870	50	0.26
NN 2113 S	592	250	1080	50	0.15
NN 2123 S	600	540	2300	50	0.32
NN 2121 S	640	492	2230	50	0.31
NN 2124 S	700	540	2730	50	0.38
NN 2114 S	710	330	1650	50	0.23
NN 2117 S	710	430	2220	50	0.31
NN 2122 S	710	530	2730	50	0.38

COURBES DE PERTE DE CHARGE | PRESSURE DROP CURVES | DRUCKABFALLKURVEN

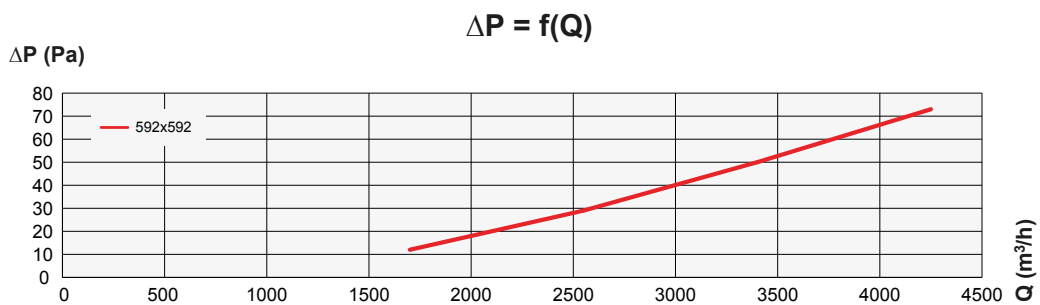

Autres dimensions sur demande.
 Other dimensions on request.
 Andere Abmessungen auf Anfrage.



FILTRES PANNEAUX - PLANS - CADRE CARTON
PANEL FILTERS - CELL - CARDBOARD FRAME
PLATTENFILTER - ZELLEN - KARTONRAHMEN

G2 - G3

Cadre / Frame / Rahmen	Carton / Cardboard / Karton
Épaisseur du cadre / Frame thickness / Rahmensdicke	24 / 48 mm
Média / Media / Media	Fibre de verre / Fiber glass / Glasfaser
Classe de filtration / Class of filtration / Filterklasse	G2 / G3 (EN 779 : 2012)
Température / Temperature / Temperatur	70 °C max.
Humidité relative / Relative humidity / Luftfeuchtigkeit	90 % max.
ΔP final recommended	250 Pa



N° Hifi	Dimensions / Abmessungen						Débit Flow Strom m³/h	ΔP initiale Initial ΔP Anfangs-ΔP Pa	Surface filtrante Filtering surface Filterierende Fläche m²
	mm			inch					
	L	I	H	L	I	H			
G2									
NN 42618 CVAN	492	395	24	20"	16"	1"	1880	35	0.19
NN 42626 CVAN	492	492	24	20"	20"	1"	2350	35	0.25
NN 43509 CVAN	592	287	24	24"	12"	1"	1700	35	0.17
NN 43518 CVAN	592	395	24	24"	16"	1"	2200	35	0.23
NN 43526 CVAN	592	492	24	24"	20"	1"	2800	35	0.29
NN 43535 CVAN	592	592	24	24"	24"	1"	3400	35	0.35
NN 44018 CVAN	622	395	24	25"	16"	1"	2350	35	0.27
NN 44026 CVAN	622	492	24	25"	20"	1"	2900	35	0.30
G3									
NN 52618 CVIN	492	395	48	20"	16"	2"	1880	55	0.19
NN 52626 CVIN	492	492	48	20"	20"	2"	2350	55	0.25
NN 53509 CVIN	592	287	48	24"	12"	2"	1700	55	0.17
NN 53518 CVIN	592	395	48	24"	16"	2"	2200	55	0.23
NN 53526 CVIN	592	492	48	24"	20"	2"	2800	55	0.29
NN 53535 CVIN	592	592	48	24"	24"	2"	3400	55	0.35
NN 54018 CVIN	622	395	48	25"	16"	2"	2350	55	0.27
NN 54026 CVIN	622	492	48	25"	20"	2"	2900	55	0.30



Autres dimensions sur demande.
 Other dimensions on request.
 Andere Abmessungen auf Anfrage.



FILTRES PANNEAUX - PLANS - CADRE CARTON



PANEL FILTERS - CELL - CARDBOARD FRAME



PLATTENFILTER - ZELLEN - KARTONRAHMEN

G2 - G3

COURBES DE PERTE DE CHARGE | PRESSURE DROP CURVES | DRUCKABFALLKURVEN

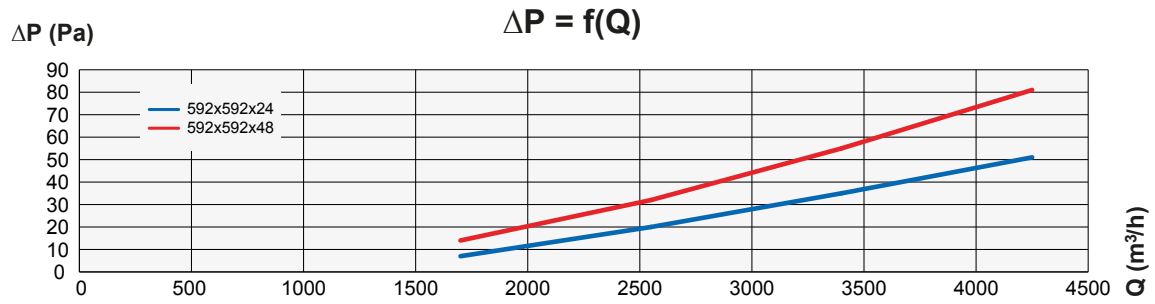



FILTRES PANNEAUX - PLISSÉS - CADRE CARTON - (SYNTHETIC)
PANEL FILTERS - PLEATED - CARDBOARD FRAME - (SYNTHETIC)
PLATTENFILTER - PLISSIERTER - KARTONRAHMEN - (SYNTHETIC)

G4

Cadre / Frame / Rahmen	Carton / Cardboard / Karton
Épaisseur du cadre / Frame thickness / Rahmenseidigkeit	24 / 48 / 96 mm
Média / Media / Media	Polyester
Classe de filtration / Class of filtration / Filterklasse	G4 (EN 779 : 2012)
Température / Temperature / Temperatur	70°C max.
Humidité relative / Relative humidity / Luftfeuchtigkeit	90 % max.
ΔP final recommended	250 Pa



N° Hifi	Dimensions / Abmessungen						Débit Flow Strom m^3/h	ΔP initiale Initial ΔP Anfangs-ΔP Pa	Surface filtrante Filtering surface Filtrierende Fläche m^2	Label énergétique Energy label Energielabel
	mm			inch						
	L	I	H	L	I	H				
24 mm										
NN 42618 CSNP	492	395	24	20"	16"	1"	1880	70	0.50	E
NN 42626 CSNP	492	492	24	20"	20"	1"	2350	70	0.60	E
NN 43509 CSNP	592	287	24	24"	12"	1"	1700	70	0.40	E
NN 43526 CSNP	592	492	24	24"	20"	1"	2800	70	0.70	E
NN 43535 CSNP	592	592	24	24"	24"	1"	3400	70	0.90	E
NN 44018 CSNP	622	395	24	25"	16"	1"	2350	70	0.60	E
NN 44026 CSNP	622	492	24	25"	20"	1"	2900	70	0.70	E
48 mm										
NN 52618 CSNP	492	395	48	20"	16"	2"	1880	55	0.70	E
NN 52626 CSNP	492	492	48	20"	20"	2"	2350	55	0.90	E
NN 53509 CSNP	592	287	48	24"	12"	2"	1700	55	0.60	E
NN 53526 CSNP	592	492	48	24"	20"	2"	2800	55	1.10	E
NN 53535 CSNP	592	592	48	24"	24"	2"	3400	55	1.40	E
NN 54018 CSNP	622	395	48	25"	16"	2"	2350	55	0.90	E
NN 54026 CSNP	622	492	48	25"	20"	2"	2900	55	1.20	E
96 mm										
NN 72618 CSNP	492	395	96	20"	16"	4"	1880	45	1.60	E
NN 72626 CSNP	492	492	96	20"	20"	4"	2350	45	1.90	E
NN 73509 CSNP	592	287	96	24"	12"	4"	1700	45	1.30	E
NN 73526 CSNP	592	492	96	24"	20"	4"	2800	45	2.30	E
NN 73535 CSNP	592	592	96	24"	24"	4"	3400	45	2.90	E
NN 74018 CSNP	622	395	96	25"	16"	4"	2350	45	2.00	E
NN 74026 CSNP	622	492	96	25"	20"	4"	2900	45	2.40	E



Autres dimensions sur demande.
 Other dimensions on request.
 Andere Abmessungen auf Anfrage.



FILTRES PANNEAUX - PLISSÉS - CADRE CARTON - (SYNTHETIC)



PANEL FILTERS - PLEATED - CARDBOARD FRAME - (SYNTHETIC)



PLATTENFILTER - PLISSIERTER - KARTONRAHMEN - (SYNTHETIC)

G4

COURBES DE PERTE DE CHARGE | PRESSURE DROP CURVES | DRUCKABFALLKURVEN

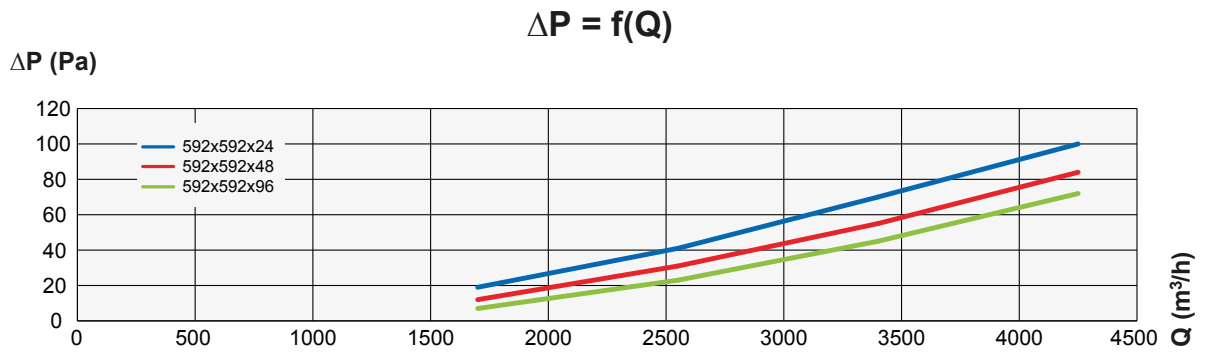



FILTRES PANNEAUX - PLISSÉS - CADRE CARTON - (SYNTHETIC-WM)
PANEL FILTERS - PLEATED - CARDBOARD FRAME - (SYNTHETIC-WM)
PLATTENFILTER - PLISSIERTER - KARTONRAHMEN - (SYNTHETIC-WM)

G4

Cadre / Frame / Rahmen	Carton / Cardboard / Karton
Épaisseur du cadre / Frame thickness / Rahmenseidke	24 / 48 / 96 mm
Média / Media / Media	Polyester (avec treillis métallique plissé / with pleated wire mesh / mit plissiertem Metallgitter)
Classe de filtration / Class of filtration / Filterklasse	G4 (EN 779 : 2012)
Température / Temperature / Temperatur	70°C max.
Humidité relative / Relative humidity / Luftfeuchtigkeit	90 % max.
ΔP final recommended	250 Pa



N° Hifi	Dimensions / Abmessungen						Débit Flow Strom <i>m³/h</i>	ΔP initiale Initial ΔP Anfangs-ΔP <i>Pa</i>	Surface filtrante Filtering surface Filterierende Fläche <i>m²</i>	Label énergétique Energy label Energietabel
	<i>mm</i>			<i>inch</i>						
	L	I	H	L	I	H				
24 mm										
NN 42618 CSNT	492	395	24	20"	16"	1"	1880	90	0.37	E
NN 42626 CSNT	492	492	24	20"	20"	1"	2350	90	0.49	E
NN 43509 CSNT	592	287	24	24"	12"	1"	1700	90	0.33	E
NN 43526 CSNT	592	492	24	24"	20"	1"	2800	90	0.56	E
NN 43535 CSNT	592	592	24	24"	24"	1"	3400	90	0.70	E
NN 44018 CSNT	622	395	24	25"	16"	1"	2350	90	0.40	E
NN 44026 CSNT	622	492	24	25"	20"	1"	2900	90	0.60	E
48 mm										
NN 52618 CSNT	492	395	48	20"	16"	2"	1880	70	0.60	E
NN 52626 CSNT	492	492	48	20"	20"	2"	2350	70	0.70	E
NN 53509 CSNT	592	287	48	24"	12"	2"	1700	70	0.50	E
NN 53526 CSNT	592	492	48	24"	20"	2"	2800	70	0.90	E
NN 53535 CSNT	592	592	48	24"	24"	2"	3400	70	1.10	E
NN 54018 CSNT	622	395	48	25"	16"	2"	2350	70	0.80	E
NN 54026 CSNT	622	492	48	25"	20"	2"	2900	70	0.90	E
96 mm										
NN 72618 CSNT	492	395	96	20"	16"	4"	1880	55	1.10	E
NN 72626 CSNT	492	492	96	20"	20"	4"	2350	55	1.50	E
NN 73509 CSNT	592	287	96	24"	12"	4"	1700	55	0.95	E
NN 73526 CSNT	592	492	96	24"	20"	4"	2800	55	1.90	E
NN 73535 CSNT	592	592	96	24"	24"	4"	3400	55	2.30	E
NN 74018 CSNT	622	395	96	25"	16"	4"	2350	55	1.50	E
NN 74026 CSNT	622	492	96	25"	20"	4"	2900	55	2.00	E



Autres dimensions sur demande.
 Other dimensions on request.
 Andere Abmessungen auf Anfrage.



FILTRES PANNEAUX - PLISSÉS - CADRE CARTON - (SYNTHETIC-WM)



PANEL FILTERS - PLEATED - CARDBOARD FRAME - (SYNTHETIC-WM)



PLATTENFILTER - PLISSIERTER - KARTONRAHMEN - (SYNTHETIC-WM)

G4

COURBES DE PERTE DE CHARGE | PRESSURE DROP CURVES | DRUCKABFALLKURVEN

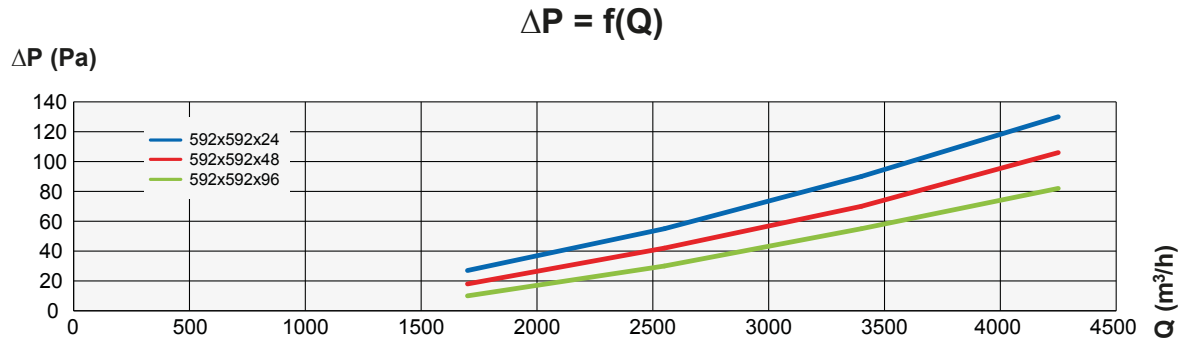



FILTRES PANNEAUX - PLISSÉS - CADRE GALVANISÉ
PANEL FILTERS - PLEATED - GALVANIZED FRAME
PLATTENFILTER - PLISSIERTER - GALVANISIERTEM RAHMEN

G4

Cadre / Frame / Rahmen	Galvanisé / Galvanized / Galvanisiertem
Épaisseur du cadre / Frame thickness / Rahmendicke	24 / 48 / 96 mm
Média / Media / Media	Polyester
Classe de filtration / Class of filtration / Filterklasse	G4 (EN 779 : 2012)
Température / Temperature / Temperatur	100°C max.
Humidité relative / Relative humidity / Luftfeuchtigkeit	95 % max.
ΔP final recommended	250 Pa



N° Hifi	Dimensions / Abmessungen						Débit Flow Strom m³/h	ΔP initiale Initial ΔP Anfangs-ΔP Pa	Surface filtrante Filtering surface Filterierende Fläche m²
	mm			inch					
	L	I	H	L	I	H			
24 mm									
NN 42618 GSNT	492	395	24	20"	16"	1"	1880	90	0.40
NN 42626 GSNT	492	492	24	20"	20"	1"	2350	90	0.50
NN 43509 GSNT	592	287	24	24"	12"	1"	1700	90	0.30
NN 43518 GSNT	592	395	24	24"	16"	1"	2250	90	0.50
NN 43526 GSNT	592	492	24	24"	20"	1"	2800	90	0.50
NN 43535 GSNT	592	592	24	24"	24"	1"	3400	90	0.70
NN 44018 GSNT	622	395	24	25"	16"	1"	2350	90	0.50
NN 44026 GSNT	622	492	24	25"	20"	1"	2900	90	0.60
48 mm									
NN 52618 GSNT	492	395	48	20"	16"	2"	1880	70	0.70
NN 52626 GSNT	492	492	48	20"	20"	2"	2350	70	0.80
NN 53509 GSNT	592	287	48	24"	12"	2"	1700	70	0.60
NN 53518 GSNT	592	395	48	24"	16"	2"	2250	70	0.80
NN 53526 GSNT	592	492	48	24"	20"	2"	2800	70	1.00
NN 53535 GSNT	592	592	48	24"	24"	2"	3400	70	1.20
NN 54018 GSNT	622	395	48	25"	16"	2"	2350	70	0.80
NN 54026 GSNT	622	492	48	25"	20"	2"	2900	70	1.10
96 mm									
NN 72618 GSNT	492	395	96	20"	16"	4"	1880	55	1.20
NN 72626 GSNT	492	492	96	20"	20"	4"	2350	55	1.50
NN 73509 GSNT	592	287	96	24"	12"	4"	1700	55	1.10
NN 73518 GSNT	592	395	96	24"	16"	4"	2250	55	1.50
NN 73526 GSNT	592	492	96	24"	20"	4"	2800	55	1.90
NN 73535 GSNT	592	592	96	24"	24"	4"	3400	55	2.40
NN 74018 GSNT	622	395	96	25"	16"	4"	2350	55	1.50
NN 74026 GSNT	622	492	96	25"	20"	4"	2900	55	1.90



Autres dimensions sur demande.
 Other dimensions on request.
 Andere Abmessungen auf Anfrage.



COURBES DE PERTE DE CHARGE | PRESSURE DROP CURVES | DRUCKABFALLKURVEN

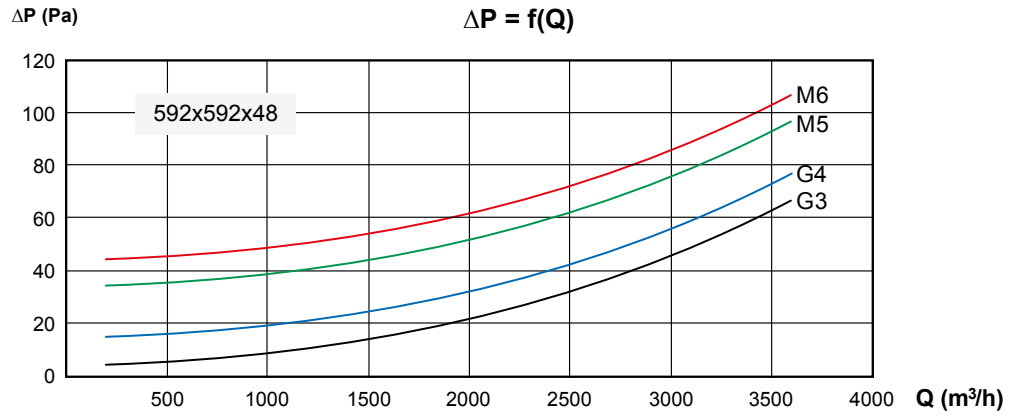



FILTRES À POCHEs - CADRE PVC

POCKET FILTERS - PVC FRAME

TASCHENFILTER - PVC RAHMEN

G4

Cadre / Frame / Rahmen	PVC
Profondeur des poches / Bag depth / Taschentiefe	125 - 360 - 500 mm
Média / Media / Media	Synthétique / Synthetic / Synthetisch
Classe de filtration / Class of filtration / Filterklasse	G4 (EN 779 : 2012)
Température / Temperature / Temperatur	90°C max.
Humidité relative / Relative humidity / Luftfeuchtigkeit	95 % max.
ΔP final recommended	250 Pa

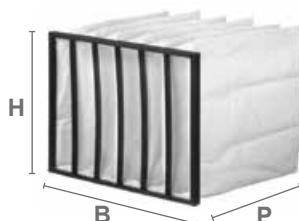

N° Hifi	Dimensions / Abmessungen mm			Nombre de poches Number of bags Anzahl Taschen	Débit Flow Strom m³/h	ΔP initiale Initial ΔP Anfangs-ΔP Pa	Surface filtrante Filtering surface Filterierende Fläche m²
	B	H	P				
125 MM							
NX 509091CPSN	287	287	125	3	750	35	0.25
NX 509351CPSN	287	592	125	3	1500	35	0.50
NX 509511CPSN	287	892	125	3	2250	35	0.70
NX 518181DPSN	395	395	125	4	1350	35	0.45
NX 520351DPSN	402	592	125	4	2000	35	0.65
NX 520511DPSN	402	892	125	4	2900	35	0.95
NX 526261EPSN	492	492	125	5	2250	35	0.65
NX 526351EPSN	492	592	125	5	2450	35	0.85
NX 526511EPSN	492	892	125	5	3600	35	1.15
NX 573461HPSN	530	762	125	8	3400	35	1.45
NX 535351FPSN	592	592	125	6	3000	35	1.00
NX 535511FPSN	592	892	125	6	4500	35	1.40
NX 563351MPSN	1192	592	125	13	6000	35	2.00
360 MM							
NX 509094CPSN	287	287	360	3	1050	56	0.60
NX 509354CPSN	287	592	360	3	2100	56	1.30
NX 509514CPSN	287	892	360	3	3150	56	1.90
NX 518184DPSN	395	395	360	4	1900	56	1.40
NX 520354DPSN	402	592	360	4	2900	56	2.00
NX 520514DPSN	402	892	360	4	4400	56	2.90
NX 526264EPSN	492	492	360	5	3000	56	2.10
NX 526354EPSN	492	592	360	5	3500	56	2.10
NX 526514EPSN	492	892	360	5	5250	56	3.20
NX 535094FPSN	592	287	360	6	2100	56	1.30
NX 535204FPSN	592	402	360	6	2900	56	2.20
NX 535264FPSN	592	492	360	6	3540	56	2.60
NX 535354FPSN	592	592	360	6	4250	56	2.60
NX 535514FPSN	592	892	360	6	6375	56	3.80
NX 551094IPSN	892	287	360	9	3200	56	2.60
NX 551204IPSN	892	402	360	9	4400	56	3.20
NX 551264IPSN	892	492	360	9	5300	56	3.90
NX 551354IPSN	892	592	360	9	6400	56	3.90



FILTRES À Poches - CADRE PVC
POCKET FILTERS - PVC FRAME
TASCHENFILTER - PVC RAHMEN

G4

N° Hifi	Dimensions / Abmessungen mm			Nombre de poches Number of bags Anzahl Taschen	Débit Flow Strom m³/h	ΔP initiale Initial ΔP Anfangs-ΔP Pa	Surface filtrante Filtering surface Filterierende Fläche m²
	B	H	P				
500 MM							
NX 509096CPSN	287	287	500	3	1060	50	0.90
NX 509356CPSN	287	592	500	3	2125	50	1.80
NX 509516CPSN	287	892	500	3	3200	50	2.70
NX 518186DPSN	395	395	500	4	1900	50	1.60
NX 520356DPSN	402	592	500	4	2900	50	2.40
NX 520516DPSN	402	892	500	4	4400	50	3.60
NX 526266EPSN	492	492	500	5	3000	50	2.50
NX 526356EPSN	492	592	500	5	3540	50	3.00
NX 526516EPSN	492	892	500	5	5300	50	4.50
NX 535096FPSN	592	287	500	6	2125	50	1.70
NX 535206FPSN	592	402	500	6	2900	50	2.50
NX 535266FPSN	592	492	500	6	3540	50	2.90
NX 535356FPSN	592	592	500	6	4250	50	3.60
NX 535516FPSN	592	892	500	6	6400	50	5.40
NX 551096IPSN	892	287	500	9	3200	50	2.60
NX 551206IPSN	892	402	500	9	4400	50	3.70
NX 551266IPSN	892	492	500	9	5300	50	4.50
NX 551356IPSN	892	592	500	9	6400	50	5.40

COURBES DE PERTE DE CHARGE | PRESSURE DROP CURVES | DRUCKABFALLKURVEN

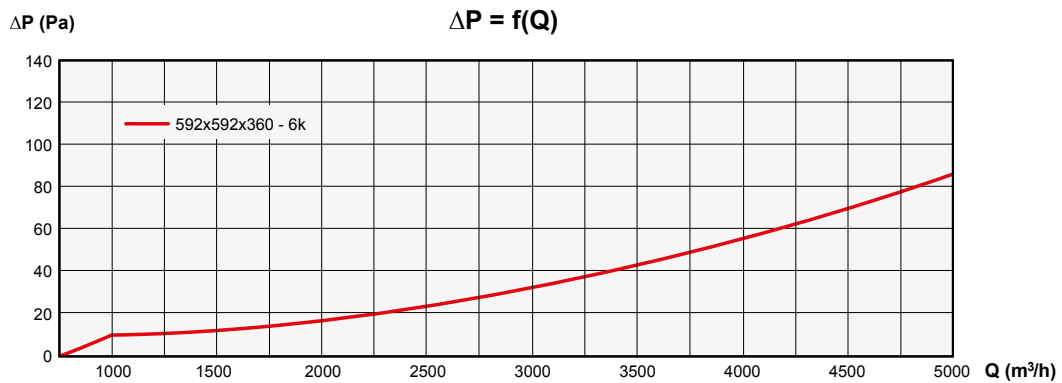

Autres dimensions sur demande.
 Other dimensions on request.
 Andere Abmessungen auf Anfrage.



FILTRES À CHAPEAUX BROUILLARD D'HUILE (15 MM)



OELNEBEL-HAUBENFILTER (15 MM)



OIL VAPOUR-HOOD FILTERS (15 MM)

G4

Cadre / Frame / Rahmen	Bois-synthétique / Wood/synthetic / Holz-Kunststoff
Profondeur des poches / Bag depth / Taschentiefe	360 mm
Média / Media / Media	Synthétique (15 mm) / Synthetic (15 mm) / Synthetisch (15 mm)
Classe de filtration / Class of filtration / Filterklasse	G4 (EN 779 : 2012)
Température / Temperature / Temperatur	80°C max.
ΔP final recommended	250 Pa

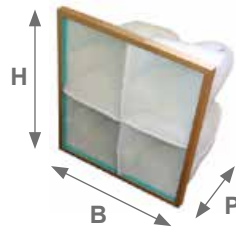

N° Hifi	Dimensions / Abmessungen mm			Nombre de bonnet Number of bag Anzahl Hauben	Débit Flow Strom m³/h	ΔP initiale Initial ΔP Anfangs-ΔP Pa	Surface filtrante Filtering surface Filterierende Fläche m²
	B	H	P				
360 MM							
NT 509094APSN	287	287	360	1	800	46	0.3
NT 509354BPSN	287	592	360	2	1650	46	0.6
NT 509514CPSN	287	892	360	3	2500	46	1.0
NT 518184DPSN	395	395	360	4	1500	46	0.8
NT 520354DPSN	402	592	360	4	2300	46	1.1
NT 520514FPSN	402	892	360	6	3500	46	1.7
NT 526264DPSN	492	492	360	4	2350	46	1.0
NT 526354DPSN	492	592	360	4	2800	46	1.2
NT 526514FPSN	492	892	360	6	4250	46	1.8
NT 535354DPSN	592	592	360	4	3400	46	1.3
NT 535514FPSN	592	892	360	6	5150	46	1.9



Autres dimensions sur demande.
Other dimensions on request.
Andere Abmessungen auf Anfrage.



FILTRES À CHAPEAUX BROUILLARD D'HUILE (40 MM)



OELNEBEL-HAUBENFILTER (40 MM)



OIL VAPOUR-HOOD FILTERS (40 MM)

G4

Cadre / Frame / Rahmen	Bois-synthétique / Wood/synthetic / Holz-Kunststoff
Profondeur des poches / Bag depth / Taschentiefe	360 - 500 mm
Média / Media / Media	Synthétique (40 mm) / Synthetic (40 mm) / Synthetisch (40 mm)
Classe de filtration / Class of filtration / Filterklasse	G4 (EN 779 : 2012)
Température / Temperature / Temperatur	80°C max.
ΔP final recommended	250 Pa

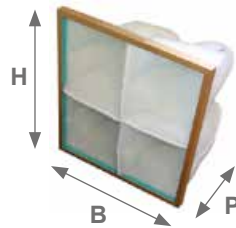

N° Hifi	Dimensions / Abmessungen mm			Nombre de bonnet Number of bag Anzahl Hauben	Débit Flow Strom m³/h	ΔP initiale Initial ΔP Anfangs-ΔP Pa	Surface filtrante Filtering surface Filterierende Fläche m²
	B	H	P				
360 MM							
NT 509094APSJ	287	287	360	1	800	87	0.3
NT 509354BPSJ	287	592	360	2	1650	87	0.6
NT 509514CPSJ	287	892	360	3	2500	87	1.0
NT 518184BPSJ	395	395	360	4	1500	87	0.80
NT 520354DPSJ	402	592	360	4	2300	87	1.1
NT 520514FPSJ	402	892	360	6	3500	87	1.7
NT 526264DPSJ	492	492	360	4	2350	87	1.0
NT 526354DPSJ	492	592	360	4	2800	87	1.2
NT 526514FPSJ	492	892	360	6	4250	87	1.8
NT 535354DPSJ	592	592	360	4	3400	87	1.3
NT 535514FPSJ	592	892	360	6	5150	87	1.9
500 MM							
NT 509096APSJ	287	287	500	1	800	75	0.4
NT 509356BPSJ	287	592	500	2	1650	75	0.9
NT 509516CPSJ	287	892	500	3	2500	75	1.3
NT 518186BPSJ	395	395	500	4	1500	75	1.0
NT 520356DPSJ	402	592	500	4	2300	75	1.3
NT 520516FPSJ	402	892	500	6	3500	75	2.3
NT 526266DPSJ	492	492	500	4	2350	75	1.3
NT 526356DPSJ	492	592	500	4	2800	75	1.5
NT 526516FPSJ	492	892	500	6	4250	75	2.4
NT 535356DPSJ	592	592	500	4	3400	75	1.7
NT 535516FPSJ	592	892	500	6	5150	75	2.6



Autres dimensions sur demande.
Other dimensions on request.
Andere Abmessungen auf Anfrage.



FILTRES À POCHEs - ORION

POCKET FILTERS - ORION

TASCHENFILTER - ORION

G4

Cadre / Frame / Rahmen	Fil galvanisé / Galvanized Wire / Verzinktem Draht
Profondeur des poches / Bag depth / Taschentiefe	125 - 150 - 350 mm
Média / Media / Media	Polyester
Classe de filtration / Class of filtration / Filterklasse	G4 (EN 779 : 2012)
Température / Temperature / Temperatur	90 C°
ΔP final recommended	250 Pa

Pour monobloc Orion et Hemair / For monobloc Orion and Hemair / Für Monobloc Orion und Hemair

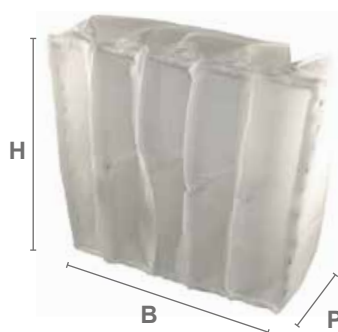

N° Hifi	Dimensions / Abmessungen mm			Nombre de poches Number of bags Anzahl Taschen	Débit Flow Strom m³/h	ΔP initiale Initial ΔP Anfangs-ΔP Pa	Surface filtrante Filtering surface Filterierende Fläche m²
	B	H	P				
NX 012124CFSN	295	295	350	3	1060	60	0.50
NX 012354CFSN	295	592	350	3	2125	60	1.00
NX 018184DFSN	395	395	350	4	1800	60	0.90
NX 026264EFSN	492	492	350	5	3000	60	1.30
NX 026354EFSN	492	592	350	5	3540	60	1.70
NX 031312EFSN	540	540	150	5	3400	60	0.70
NX 035351FFSN	592	592	125	6	4250	60	1.00
NX 035354FFSN	592	592	350	6	4250	60	2.00



Autres dimensions sur demande.
Other dimensions on request.
Andere Abmessungen auf Anfrage.

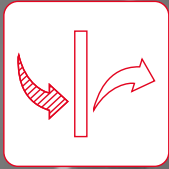

SOMMAIRE

CONTENTS

INHALTSVERZEICHNIS

A^B
C...

Codification
Codification
Legende

1 - 6

G

Préfiltre - Filtration gravimétrique
Prefilter - *Gravimetric filtration*
Vorfilter - *Gravimetrische Filtrierung*

7 - 28

F

Filtres fins - Filtration opacimétrique
Fine filter - *Opacimetric filtration*
Feinstaubfilter - *Opazimetrische Filtrierung*

29 - 48

H

Filtres absolus - Filtration absolue HEPA
Absolute filters - *Absolute HEPA filtration*
Schwebstoff-filter - *HEPA Schwebstofffilter*

49 - 64

CA
CAG

Adsorption - Filtres charbon actif
Adsorption - *Carbon filters*
Adsorbierung - *Aktivkohle-Filteractive*

65 - 68



Recommandations générales
General advices
Allgemeine Hinweise

Trucs et astuces
Tricks and clever bits
Tipps

Nos catalogues
Our catalogues
Unsere Kataloge

Conditions générales de vente
General terms of sales
Allgemeine Geschäftsbedingungen

69 - 80



FILTRES PANNEAUX - MINI-PLIS - CADRE GALVANISÉ
PANEL FILTERS - MINI PLEATS - GALVANIZED FRAME
PLATTENFILTER - MAKROFALT - GALVANISIERTEM RAHMEN

M5 - M6 - F7 - F8 - F9

Cadre / Frame / Rahmen	Galvanisé / Galvanized / Galvanisiertem
Épaisseur du cadre / Frame thickness / Rahmenseidie	48 / 96 mm
Média / Media / Media	Synthétique / Synthetic
Classe de filtration / Class of filtration / Filterklasse	M5 - M6 - F7 - F8 - F9 (EN 779 : 2012)
Température / Temperature / Temperatur	80°C max.
Humidité relative / Relative humidity / Luftfeuchtigkeit	90 % max.
ΔP final recommended	450 Pa
Séparateurs / Separators / Trenner	Hotmelt



N° Hifi	Dimensions / Abmessungen						Débit Flow Strom m³/h	ΔP initiale Initial ΔP Anfangs-ΔP Pa	Surface filtrante Filtering surface Filterierende Fläche m²
	mm			inch					
	L	I	H	L	I	H			
M5									
NN 53509 GTAP	592	287	48	24"	12"	2"	1120	38	2.5
NN 53526 GTAP	592	492	48	24"	20"	2"	1870	38	4.3
NN 53535 GTAP	592	592	48	24"	24"	2"	2250	38	5.2
NN 73509 GTAP	592	287	96	24"	12"	4"	1700	65	5.2
NN 73526 GTAP	592	492	96	24"	20"	4"	2825	65	9.1
NN 73535 GTAP	592	592	96	24"	24"	4"	3400	65	11.0
M6									
NN 53509 GTBP	592	287	48	24"	12"	2"	1120	48	2.5
NN 53526 GTBP	592	492	48	24"	20"	2"	1870	48	4.3
NN 53535 GTBP	592	592	48	24"	24"	2"	2250	48	5.2
NN 73509 GTBP	592	287	96	24"	12"	4"	1700	84	5.2
NN 73526 GTBP	592	492	96	24"	20"	4"	2825	84	9.1
NN 73535 GTBP	592	592	96	24"	24"	4"	3400	84	11.0
F7									
NN 53509 GTCP	592	287	48	24"	12"	2"	1120	69	2.5
NN 53526 GTCP	592	492	48	24"	20"	2"	1870	69	4.3
NN 53535 GTCP	592	592	48	24"	24"	2"	2250	69	5.2
NN 73509 GTCP	592	287	96	24"	12"	4"	1700	105	5.2
NN 73526 GTCP	592	492	96	24"	20"	4"	2825	105	9.1
NN 73535 GTCP	592	592	96	24"	24"	4"	3400	105	11.0
F8									
NN 53509 GTDP	592	287	48	24"	12"	2"	1120	106	2.5
NN 53526 GTDP	592	492	48	24"	20"	2"	1870	106	4.3
NN 53535 GTDP	592	592	48	24"	24"	2"	2250	106	5.2
NN 73509 GTDP	592	287	96	24"	12"	4"	1700	139	5.2
NN 73526 GTDP	592	492	96	24"	20"	4"	2825	139	9.1
NN 73535 GTDP	592	592	96	24"	24"	4"	3400	139	11.0
F9									
NN 53509 GTEP	592	287	48	24"	12"	2"	1120	140	2.5
NN 53526 GTEP	592	492	48	24"	20"	2"	1870	140	4.3
NN 53535 GTEP	592	592	48	24"	24"	2"	2250	140	5.2
NN 73509 GTEP	592	287	96	24"	12"	4"	1700	190	5.2
NN 73526 GTEP	592	492	96	24"	20"	4"	2825	190	9.1
NN 73535 GTEP	592	592	96	24"	24"	4"	3400	190	11.0



Autres dimensions sur demande.
 Other dimensions on request.
 Andere Abmessungen auf Anfrage.



FILTRES PANNEAUX - MINI-PLIS - CADRE GALVANISÉ
 PANEL FILTERS - MINI PLEATS - GALVANIZED FRAME
 PLATTENFILTER - MAKROFALT - GALVANISIERTEM RAHMEN

M5 - M6 - F7 - F8 - F9

COURBES DE PERTE DE CHARGE | PRESSURE DROP CURVES | DRUCKABFALLKURVEN

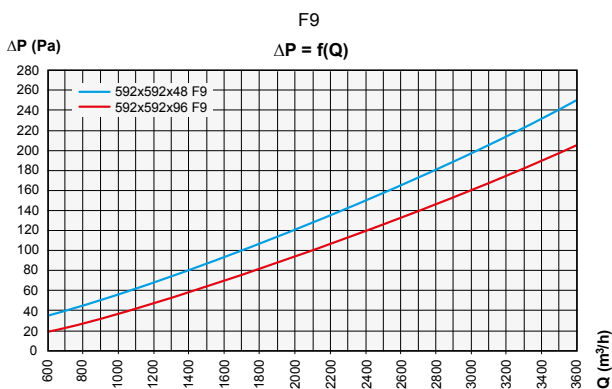
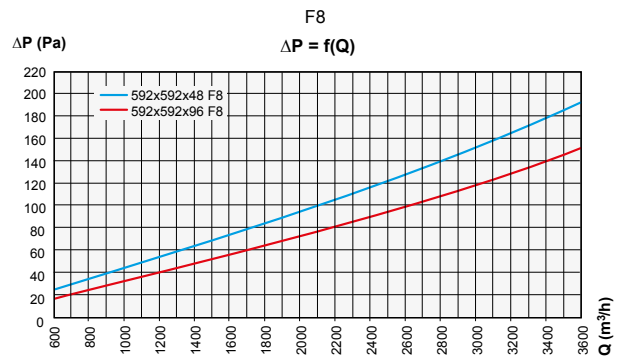
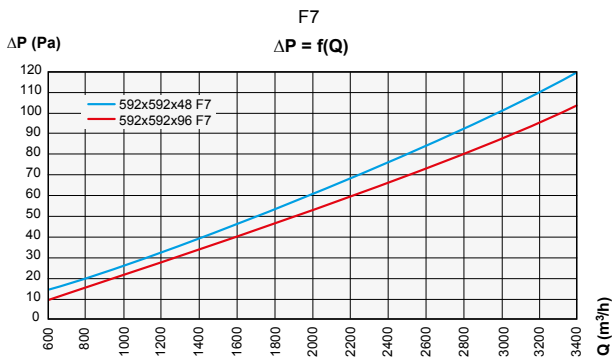
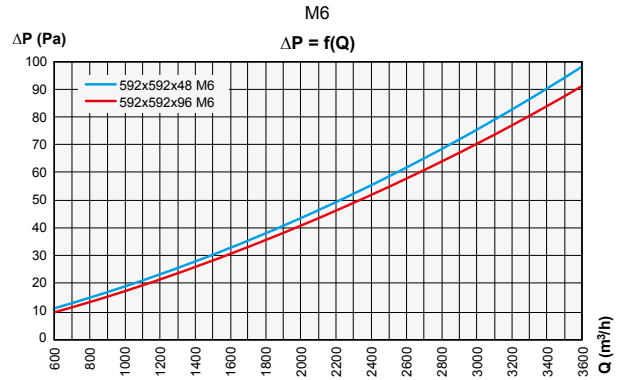
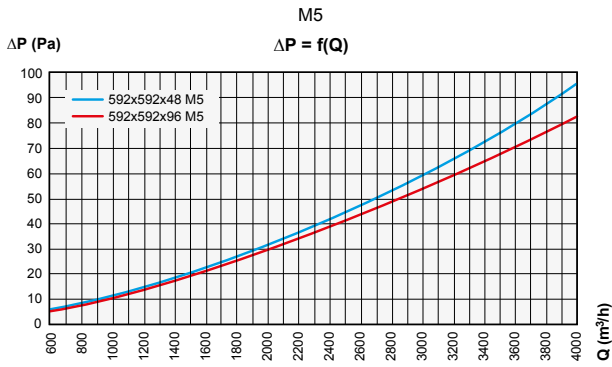



FILTRES PANNEAUX - MINI-PLIS - CADRE PLASTIQUE

PANEL FILTERS - MINI PLEATS - PLASTIC FRAME

PLATTENFILTER - MAKROFALT - KUNSTSTOFFRAHMEN

M5 - M6 - F7 - F8 - F9

Cadre / Frame / Rahmen	Plastique / Plastic / Kunststoff
Épaisseur du cadre / Frame thickness / Rahmenseidie	48 / 96 mm
Média / Media / Media	Synthétique / Synthetic
Classe de filtration / Class of filtration / Filterklasse	M5 - M6 - F7 - F8 - F9 (EN 779 : 2012)
Température / Temperature / Temperatur	70°C max.
Humidité relative / Relative humidity / Luftfeuchtigkeit	90 % max.
ΔP final recommended	450 Pa
Séparateurs / Separators / Trenner	Hotmelt



N° Hifi	Dimensions / Abmessungen						Débit Flow Strom m³/h	ΔP initiale Initial ΔP Anfangs-ΔP Pa	Surface filtrante Filtering surface Filtrierende Fläche m²
	mm			inch					
	L	I	P	L	I	P			
M5									
NN 53509 PTAP	592	287	48	24"	12"	2"	1120	38	2.5
NN 53526 PTAP	592	492	48	24"	20"	2"	1870	38	4.3
NN 53535 PTAP	592	592	48	24"	24"	2"	2250	38	5.2
NN 73509 PTAP	592	287	96	24"	12"	4"	1700	65	5.2
NN 73526 PTAP	592	492	96	24"	20"	4"	2825	65	9.1
NN 73535 PTAP	592	592	96	24"	24"	4"	3400	65	11.0
M6									
NN 53509 PTBP	592	287	48	24"	12"	2"	1120	48	2.5
NN 53535 PTBP	592	492	48	24"	20"	2"	1870	48	5.2
NN 53526 PTBP	592	592	48	24"	24"	2"	2250	48	4.3
NN 73509 PTBP	592	287	96	24"	12"	4"	1700	84	5.2
NN 73526 PTBP	592	492	96	24"	20"	4"	2825	84	9.1
NN 73535 PTBP	592	592	96	24"	24"	4"	3400	84	11.0
F7									
NN 53509 PTCF	592	287	48	24"	12"	2"	1120	69	2.5
NN 53526 PTCF	592	492	48	24"	20"	2"	1870	69	4.3
NN 53535 PTCF	592	592	48	24"	24"	2"	2250	69	5.2
NN 73509 PTCF	592	287	96	24"	12"	4"	1700	105	5.2
NN 73526 PTCF	592	492	96	24"	20"	4"	2825	105	9.1
NN 73535 PTCF	592	592	96	24"	24"	4"	3400	105	11.0
F8									
NN 53509 PTDF	592	287	48	24"	12"	2"	1120	106	2.5
NN 53526 PTDF	592	492	48	24"	20"	2"	1870	106	4.3
NN 53535 PTDF	592	592	48	24"	24"	2"	2250	106	5.2
NN 73509 PTDF	592	287	96	24"	12"	4"	1700	139	5.2
NN 73526 PTDF	592	492	96	24"	20"	4"	2825	139	9.1
NN 73535 PTDF	592	592	96	24"	24"	4"	3400	139	11.0
F9									
NN 53509 PTEP	592	287	48	24"	12"	2"	1120	140	2.5
NN 53526 PTEP	592	492	48	24"	20"	2"	1870	140	4.3
NN 53535 PTEP	592	592	48	24"	24"	2"	2250	140	5.2
NN 73509 PTEP	592	287	96	24"	12"	4"	1700	190	5.2
NN 73526 PTEP	592	492	96	24"	20"	4"	2825	190	9.1
NN 73535 PTEP	592	592	96	24"	24"	4"	3400	190	11.0



Autres dimensions sur demande.
Other dimensions on request.
Andere Abmessungen auf Anfrage.



FILTRES PANNEAUX - MINI-PLIS - CADRE PLASTIQUE



PANEL FILTERS - MINI PLEATS - PLASTIC FRAME



PLATTENFILTER - MAKROFALT - KUNSTSTOFFRAHMEN

M5 - M6 - F7 - F8 - F9

COURBES DE PERTE DE CHARGE | PRESSURE DROP CURVES | DRUCKABFALLKURVEN

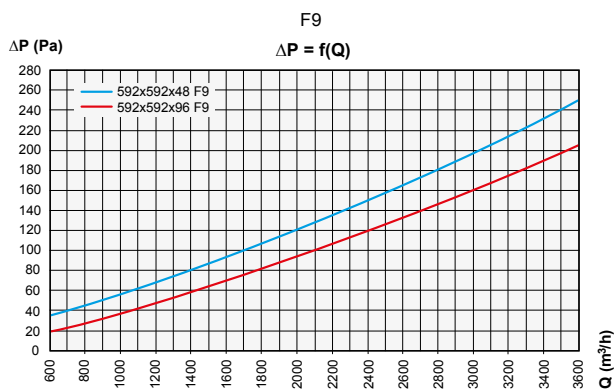
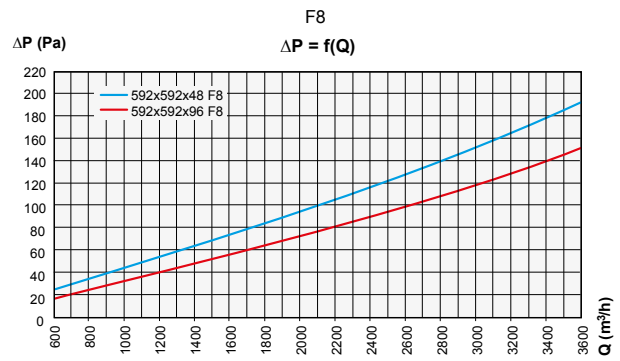
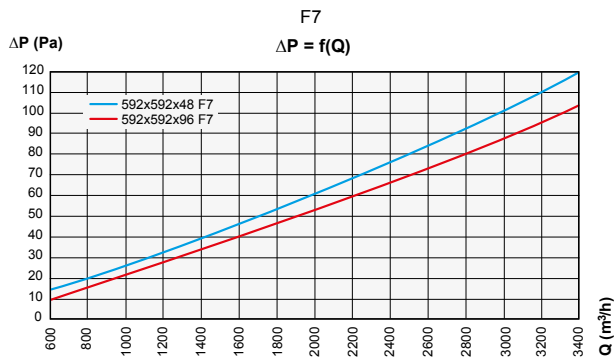
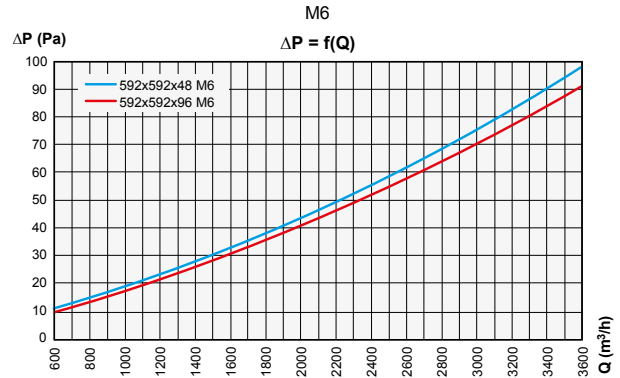
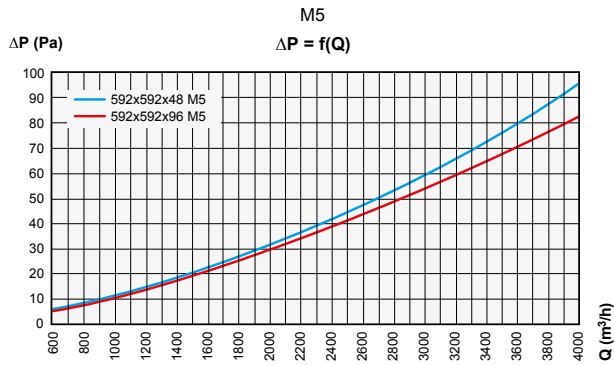



FILTRES À POCHEs - ORION

POCKET FILTERS - ORION

TASCHENFILTER - ORION

M5

Cadre / Frame / Rahmen	Fil galvanisé / Galvanized Wire / Verzinktem Draht
Profondeur des poches / Bag depth / Taschentiefe	520
Média / Media / Media	Synthétique / Synthetic / Synthetisch
Classe de filtration / Class of filtration / Filterklasse	M5 (EN 779 : 2012)
Température / Temperature / Temperatur	90°C
ΔP final recommended	250 Pa

Pour monobloc Orion et Hemair / For monobloc Orion and Hemair / Für Monobloc Orion und Hemair

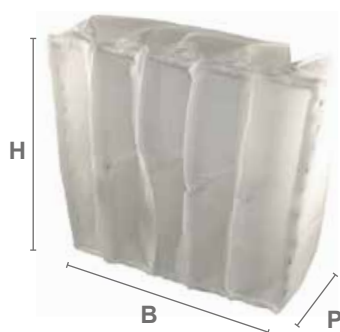

N° Hifi	Dimensions / Abmessungen mm			Nombre de poches Number of bags Anzahl Taschen	Débit Flow Strom m³/h	ΔP initiale Initial ΔP Anfangs-ΔP Pa	Surface filtrante Filtering surface Filterierende Fläche m²
	B	H	P				
NX 007316CFTA	240	540	520	3	1200	85	1.30
NX 009416CFTA	287	650	520	3	1700	85	1.90
NX 012126CFTA	295	295	520	3	870	85	0.90
NX 012356CFTA	295	592	520	3	1750	85	1.80
NX 018186DFTA	395	395	520	4	1500	85	1.60
NX 026266EFTA	492	492	520	5	2500	85	2.50
NX 035356FFTA	592	592	520	6	3400	85	3.60



Autres dimensions sur demande.
Other dimensions on request.
Andere Abmessungen auf Anfrage.



FILTRES À CHAPEAUX BROUILLARD D'HUILE

OELNEBEL-HAUBENFILTER

OIL VAPOUR-HOOD FILTERS

M5

Cadre / Frame / Rahmen	Bois-synthétique / Wood/synthetic / Holz-Kunststoff
Profondeur des poches / Bag depth / Taschentiefe	360 - 500 mm
Média / Media / Media	PES - Fibre de verre / PES - Fiberglass / PES - Glasfaser
Classe de filtration / Class of filtration / Filterklasse	M5 (EN 779 : 2012)
Température / Temperature / Temperatur	80°C max.
ΔP final recommended	250 Pa

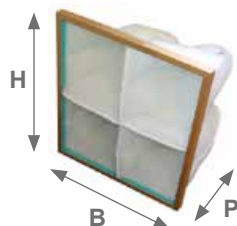

N° Hifi	Dimensions / Abmessungen mm			Nombre de bonnet Number of bag Anzahl Hauben	Débit Flow Strom m³/h	ΔP initiale Initial ΔP Anfangs-ΔP Pa	Surface filtrante Filtering surface Filterierende Fläche m²
	B	H	P				
360 MM							
NT 509094APSG	287	287	360	1	750	105	0.3
NT 509354BPSG	287	592	360	2	1500	105	0.6
NT 509514CPSG	287	892	360	3	2250	105	1.0
NT 518184BPSG	395	395	360	4	1350	105	0.80
NT 520354DPSG	402	592	360	4	2000	105	1.1
NT 520514FPSG	402	892	360	6	2900	105	1.7
NT 526264DPSG	492	492	360	4	2250	105	1.0
NT 526354DPSG	492	592	360	4	2450	105	1.2
NT 526514FPSG	492	892	360	6	3600	105	1.8
NT 535354DPSG	592	592	360	4	3000	105	1.3
NT 535514FPSG	592	892	360	6	4500	105	1.9
500 MM							
NT 509096APSG	287	287	500	1	850	103	0.4
NT 509356BPSG	287	592	500	2	1700	103	0.9
NT 509516CPSG	287	892	500	3	2550	103	1.3
NT 518186BPSG	395	395	500	4	1520	103	1.0
NT 520356DPSG	402	592	500	4	2300	103	1.3
NT 520516FPSG	402	892	500	6	3500	103	2.3
NT 526266DPSG	492	492	500	4	2400	103	1.3
NT 526356DPSG	492	592	500	4	2800	103	1.5
NT 526516FPSG	492	892	500	6	4250	103	2.4
NT 535356DPSG	592	592	500	4	3400	103	1.7
NT 535516FPSG	592	892	500	6	5100	103	2.6



Autres dimensions sur demande.
Other dimensions on request.
Andere Abmessungen auf Anfrage.



FILTRES À POCHEs - CADRE PVC

POCKET FILTERS - PVC FRAME

TASCHENFILTER - PVC RAHMEN

M5

Cadre / Frame / Rahmen	PVC
Profondeur des poches / Bag depth / Taschentiefe	360 - 500 - 620 mm
Média / Media / Media	Synthétique / Synthetic / Synthetisch
Classe de filtration / Class of filtration / Filterklasse	M5 (EN 779 : 2012)
Température / Temperature / Temperatur	80°C max.
Humidité relative / Relative humidity / Luftfeuchtigkeit	90 % max.
ΔP final recommended	450 Pa

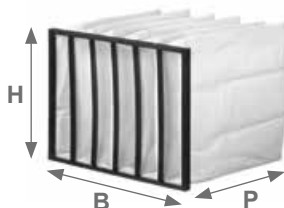

N° Hifi	Dimensions / Abmessungen mm			Nombre de poches Number of bags Anzahl Taschen	Débit Flow Strom m³/h	ΔP initiale Initial ΔP Anfangs-ΔP Pa	Surface filtrante Filtering surface Filterierende Fläche m²
	B	H	P				
360 MM							
NX 509094CPTA	287	287	360	3	800	59	0.60
NX 509354CPTA	287	592	360	3	1700	59	1.30
NX 509514CPTA	287	892	360	3	2250	59	2.00
NX 518184DPTA	395	395	360	4	1350	59	1.20
NX 520354DPTA	402	592	360	4	2000	59	1.70
NX 520514DPTA	402	892	360	4	2900	59	2.60
NX 526264EPTA	492	492	360	5	2250	59	1.80
NX 526354EPTA	492	592	360	5	2700	59	2.10
NX 526514EPTA	492	892	360	5	3600	59	3.20
NX 535094FPTA	592	287	360	6	1500	59	1.20
NX 535204FPTA	592	402	360	6	2000	59	1.80
NX 535264FPTA	592	492	360	6	2450	59	2.10
NX 535354FPTA	592	592	360	6	3400	59	2.60
NX 535514FPTA	592	892	360	6	4500	59	3.90
NX 551094IPTA	892	287	360	9	2250	59	1.90
NX 551204IPTA	892	402	360	9	2900	59	2.70
NX 551264IPTA	892	492	360	9	3600	59	3.20
NX 551354IPTA	892	592	360	9	4500	59	3.90
500 MM							
NX 509096CPTA	287	287	500	3	800	49	0.90
NX 509356CPTA	287	592	500	3	1700	49	1.80
NX 509516CPTA	287	892	500	3	2550	49	2.70
NX 518186DPTA	395	395	500	4	1520	49	1.60
NX 520356DPTA	402	592	500	4	2300	49	2.40
NX 520516DPTA	402	892	500	4	3500	49	3.60
NX 526266EPTA	492	492	500	5	2400	49	2.50
NX 526356EPTA	492	592	500	5	2700	49	3.00
NX 526516EPTA	492	892	500	5	4250	49	4.50
NX 535096FPTA	592	287	500	6	1700	49	1.70
NX 535206FPTA	592	402	500	6	2300	49	2.50
NX 535266FPTA	592	492	500	6	2800	49	2.90
NX 535356FPTA	592	592	500	6	3400	49	3.60
NX 535516FPTA	592	892	500	6	5100	49	5.40
NX 551096IPTA	892	287	500	9	2550	49	2.60
NX 551206IPTA	892	402	500	9	3500	49	3.70
NX 551266IPTA	892	492	500	9	4250	49	4.50
NX 551356IPTA	892	592	500	9	5100	49	5.40



FILTRES À Poches - CADRE PVC
POCKET FILTERS - PVC FRAME
TASCHENFILTER - PVC RAHMEN

M5

N° Hifi	Dimensions / Abmessungen mm			Nombre de poches Number of bags Anzahl Taschen	Débit Flow Strom m³/h	ΔP initiale Initial ΔP Anfangs-ΔP Pa	Surface filtrante Filtering surface Filterierende Fläche m²
	B	H	P				
620 MM							
NX 509097CPTA	287	287	620	3	800	45	1.27
NX 509357CPTA	287	592	620	3	1700	45	2.40
NX 509517CPTA	287	892	620	3	2600	45	3.60
NX 518187DPTA	395	395	620	4	1500	45	2.40
NX 520357DPTA	402	592	620	4	2350	45	3.20
NX 520517DPTA	402	892	620	4	3400	45	4.88
NX 526267FPTA	492	492	620	6	2500	45	4.30
NX 526357EPTA	492	592	620	5	2700	45	3.90
NX 526517FPTA	492	892	620	6	4200	45	7.30
NX 535097FPTA	592	287	620	6	1750	45	2.60
NX 535207FPTA	592	402	620	6	2350	45	3.40
NX 535267FPTA	592	492	620	6	2800	45	4.00
NX 535357FPTA	592	592	620	6	3400	45	4.70
NX 535517FPTA	592	892	620	6	5250	45	8.48
NX 551097JPTA	892	287	620	10	2600	45	3.83
NX 551207JPTA	892	402	620	10	3400	45	5.08
NX 551267JPTA	892	492	620	10	4200	45	6.00
NX 551357JPTA	892	592	620	10	5250	45	7.08

COURBES DE PERTE DE CHARGE | PRESSURE DROP CURVES | DRUCKABFALLKURVEN

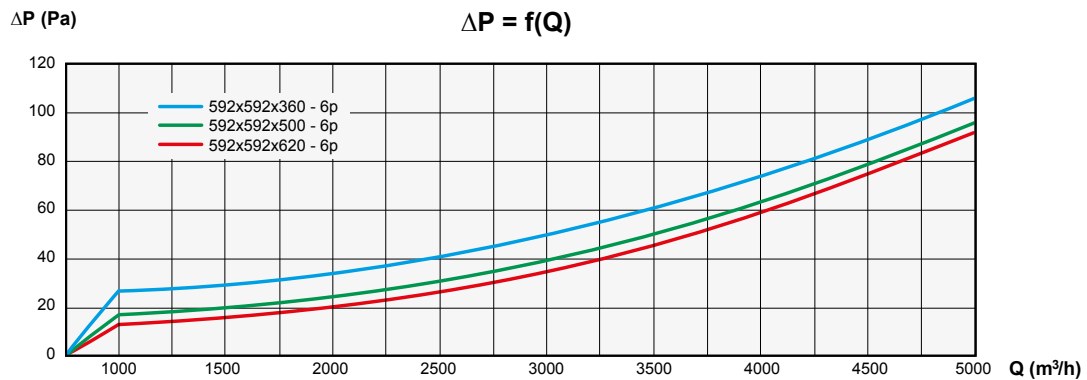

Autres dimensions sur demande.
 Other dimensions on request.
 Andere Abmessungen auf Anfrage.



FILTRES À POCHEs - CADRE PVC

POCKET FILTERS - PVC FRAME

TASCHENFILTER - PVC RAHMEN

M6

Cadre / Frame / Rahmen	PVC
Profondeur des poches / Bag depth / Taschentiefe	380 - 525 - 635 mm
Média / Media / Media	Synthétique / Synthetic / Synthetisch
Classe de filtration / Class of filtration / Filterklasse	M6 (EN 779 : 2012)
Température / Temperature / Temperatur	80°C max.
Humidité relative / Relative humidity / Luftfeuchtigkeit	90 % max.
ΔP final recommended	450 Pa

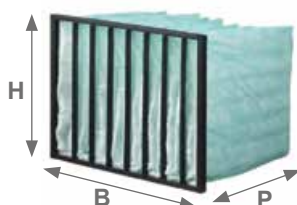

N° Hifi	Dimensions / Abmessungen mm			Nombre de poches Number of bags Anzahl Taschen	Débit Flow Strom m³/h	ΔP initiale Initial ΔP Anfangs-ΔP Pa	Surface filtrante Filtering surface Filterierende Fläche m²
	B	H	P				
380 MM							
NX 509094DPA6	287	287	380	4	800	90	1.00
NX 509354DPA6	287	592	380	4	1700	90	1.90
NX 509514DPA6	287	892	380	4	2500	90	2.80
NX 520354EPA6	402	592	380	5	2000	90	2.60
NX 520514EPA6	402	892	380	5	2900	90	3.80
NX 526264FPA6	492	492	380	6	2250	90	2.70
NX 526354FPA6	492	592	380	6	2700	90	2.90
NX 526514FPA6	492	892	380	6	4000	90	4.20
NX 535094HPA6	592	287	380	8	1700	90	2.10
NX 535204HPA6	592	402	380	8	2000	90	3.00
NX 535264HPA6	592	492	380	8	2800	90	3.20
NX 535354HPA6	592	592	380	8	3400	90	3.80
NX 535514HPA6	592	892	380	8	5000	90	5.50
NX 551094LPA6	892	287	380	12	2250	90	2.30
NX 551204LPA6	892	402	380	12	2900	90	3.80
NX 551264LPA6	892	492	380	12	3600	90	4.40
NX 551354LPA6	892	592	380	12	4500	90	5.20
525 MM							
NX 509096DPA6	287	287	525	4	800	80	1.40
NX 509356DPA6	287	592	525	4	1700	80	2.60
NX 509516DPA6	287	892	525	4	2500	80	3.80
NX 518186EPA6	395	395	525	5	1400	80	2.50
NX 520356EPA6	402	592	525	5	2200	80	3.60
NX 520516EPA6	402	892	525	5	3200	80	5.20
NX 526266FPA6	492	492	525	6	2350	80	3.60
NX 526356FPA6	492	592	525	6	2700	80	4.00
NX 526516FPA6	492	892	525	6	3950	80	5.80
NX 535096HPA6	592	287	525	8	1700	80	2.90
NX 535206HPA6	592	402	525	8	2200	80	4.10
NX 535266HPA6	592	492	525	8	2800	80	4.50
NX 535356HPA6	592	592	525	8	3400	80	5.30
NX 535516HPA6	592	892	525	8	5000	80	7.70
NX 551096LPA6	892	287	525	12	2450	80	3.90
NX 551206LPA6	892	402	525	12	3200	80	5.10
NX 551266LPA6	892	492	525	12	4000	80	6.00
NX 551356LPA6	892	592	525	12	4950	80	7.10



FILTRES À POCHEs - CADRE PVC

POCKET FILTERS - PVC FRAME

TASCHENFILTER - PVC RAHMEN

M6

N° Hifi	Dimensions / Abmessungen mm			Nombre de poches Number of bags Anzahl Taschen	Débit Flow Strom m^3/h	ΔP initiale Initial ΔP Anfangs- ΔP Pa	Surface filtrante Filtering surface Filterierende Fläche m^2
	B	H	P				
635 MM							
NX 509097DPA6	287	287	635	4	800	75	1.70
NX 509357DPA6	287	592	635	4	1700	75	3.20
NX 509517DPA6	287	892	635	4	2600	75	4.80
NX 518187EPA6	395	395	635	5	1500	75	3.00
NX 520357EPA6	402	592	635	5	2350	75	4.20
NX 520517EPA6	402	892	635	5	3400	75	6.10
NX 526267FPA6	492	492	635	6	2500	75	4.30
NX 526357FPA6	492	592	635	6	2700	75	4.80
NX 526517FPA6	492	892	635	6	4200	75	7.30
NX 535097HPA6	592	287	635	8	1750	75	3.30
NX 535207HPA6	592	402	635	8	2350	75	4.90
NX 535267HPA6	592	492	635	8	2800	75	5.60
NX 535357HPA6	592	592	635	8	3400	75	6.50
NX 535517HPA6	592	892	635	8	5250	75	9.70
NX 551097LPA6	892	287	635	12	2600	75	4.60
NX 551207LPA6	892	402	635	12	3400	75	6.10
NX 551267LPA6	892	492	635	12	4200	75	7.20
NX 551357LPA6	892	592	635	12	5250	75	8.50

COURBES DE PERTE DE CHARGE | PRESSURE DROP CURVES | DRUCKABFALLKURVEN

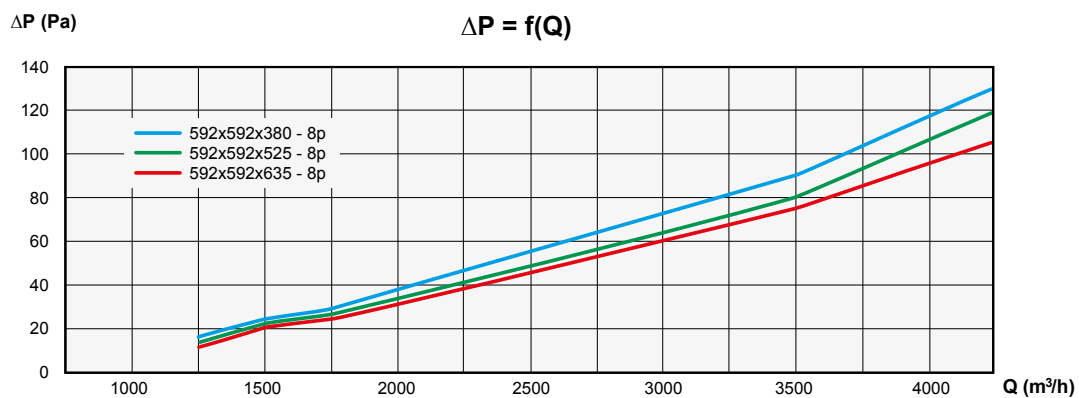

Autres dimensions sur demande.
Other dimensions on request.
Andere Abmessungen auf Anfrage.



FILTRES À POCHEs - CADRE PVC

POCKET FILTERS - PVC FRAME

TASCHENFILTER - PVC RAHMEN

F7

Cadre / Frame / Rahmen	PVC
Profondeur des poches / Bag depth / Taschentiefe	380 - 525 - 635 mm
Média / Media / Media	Synthétique / Synthetic / Synthetisch
Classe de filtration / Class of filtration / Filterklasse	F7 (EN 779 : 2012)
Température / Temperature / Temperatur	80°C max.
Humidité relative / Relative humidity / Luftfeuchtigkeit	90 % max.
ΔP final recommended	450 Pa



N° Hifi	Dimensions / Abmessungen mm			Nombre de poches Number of bags Anzahl Taschen	Débit Flow Strom m³/h	ΔP initiale Initial ΔP Anfangs-ΔP Pa	Surface filtrante Filtering surface Filterierende Fläche m²
	B	H	P				
380 MM							
NX 509094DPA7	287	287	380	4	800	115	1.00
NX 509354DPA7	287	592	380	4	1700	115	1.90
NX 509514DPA7	287	892	380	4	2500	115	2.80
NX 518184EPA7	395	395	380	5	1350	115	1.80
NX 520354EPA7	402	592	380	5	2000	115	2.60
NX 520514EPA7	402	892	380	5	2900	115	3.80
NX 526264FPA7	492	492	380	6	2250	115	2.70
NX 526354FPA7	492	592	380	6	2700	115	2.90
NX 526514FPA7	492	892	380	6	4000	115	4.20
NX 535094HPA7	592	287	380	8	1700	115	2.10
NX 535204HPA7	592	402	380	8	2000	115	3.00
NX 535264HPA7	592	492	380	8	2800	115	3.20
NX 535354HPA7	592	592	380	8	3400	115	3.80
NX 535514HPA7	592	892	380	8	5000	115	5.50
NX 551094LPA7	892	287	380	12	2250	115	2.90
NX 551204LPA7	892	402	380	12	2900	115	3.80
NX 551264LPA7	892	492	380	12	3600	115	4.40
NX 551354LPA7	892	592	380	12	4500	115	5.20
525 MM							
NX 509096DPA7	287	287	525	4	800	100	1.40
NX 509356DPA7	287	592	525	4	1700	100	2.60
NX 509516DPA7	287	892	525	4	2500	100	3.80
NX 518186EPA7	395	395	525	5	1400	100	2.50
NX 520356EPA7	402	592	525	5	2200	100	3.60
NX 520516EPA7	402	892	525	5	3200	100	5.20
NX 526266FPA7	492	492	525	6	2350	100	3.60
NX 526356FPA7	492	592	525	6	2700	100	4.00
NX 526516FPA7	492	892	525	6	4000	100	5.80
NX 535096HPA7	592	287	525	8	1700	100	2.90
NX 535206HPA7	592	402	525	8	2200	100	4.10
NX 535266HPA7	592	492	525	8	2800	100	4.50
NX 535356HPA7	592	592	525	8	3400	100	5.30
NX 535516HPA7	592	892	525	8	5000	100	7.70
NX 551096LPA7	892	287	525	12	2450	100	3.90
NX 551206LPA7	892	402	525	12	3200	100	5.10
NX 551266LPA7	892	492	525	12	3950	100	6.00
NX 551356LPA7	892	592	525	12	4950	100	7.10



FILTRES À PochES - CADRE PVC
POCKET FILTERS - PVC FRAME
TASCHENFILTER - PVC RAHMEN

F7

N° Hifi	Dimensions / Abmessungen mm			Nombre de poches Number of bags Anzahl Taschen	Débit Flow Strom m³/h	ΔP initiale Initial ΔP Anfangs-ΔP Pa	Surface filtrante Filtering surface Filterierende Fläche m²
	B	H	P				
635 MM							
NX 509097DPA7	287	287	635	4	800	90	1.70
NX 509357DPA7	287	592	635	4	1700	90	3.20
NX 509517DPA7	287	892	635	4	2600	90	4.80
NX 518187EPA7	395	395	635	5	1500	90	3.00
NX 520357EPA7	402	592	635	5	2350	90	4.20
NX 520517EPA7	402	892	635	5	3400	90	6.10
NX 526267FPA7	492	492	635	6	2500	90	4.30
NX 526357FPA7	492	592	635	6	2700	90	4.80
NX 526517FPA7	492	892	635	6	4200	90	7.30
NX 535097HPA7	592	287	635	8	1750	90	3.30
NX 535207HPA7	592	402	635	8	2350	90	4.90
NX 535267HPA7	592	492	635	8	2800	90	5.50
NX 535357HPA7	592	592	635	8	3400	90	6.50
NX 535517HPA7	592	892	635	8	5250	90	9.70
NX 551097LPA7	892	287	635	12	2600	90	4.60
NX 551207LPA7	892	402	635	12	3400	90	6.10
NX 551267LPA7	892	492	635	12	4200	90	7.20
NX 551357LPA7	892	592	635	12	5250	90	8.50

COURBES DE PERTE DE CHARGE | PRESSURE DROP CURVES | DRUCKABFALLKURVEN

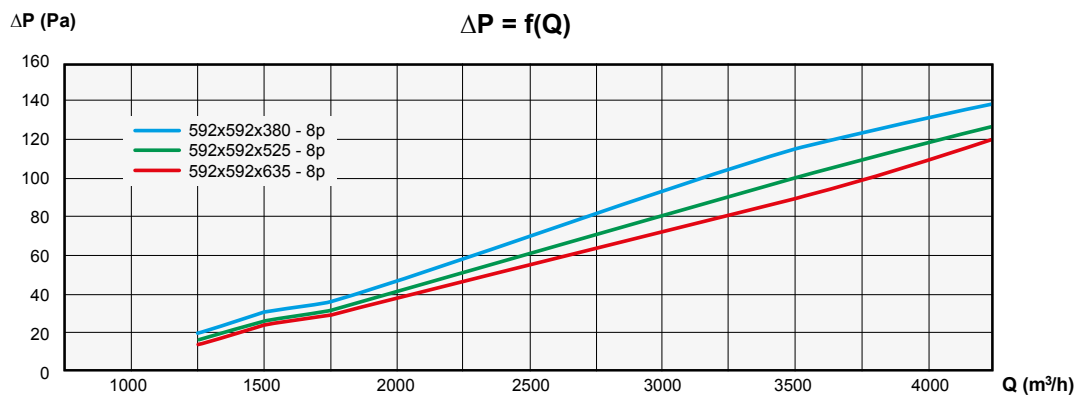

Autres dimensions sur demande.
 Other dimensions on request.
 Andere Abmessungen auf Anfrage.



FILTRES À POCHEs - CADRE PVC

POCKET FILTERS - PVC FRAME

TASCHENFILTER - PVC RAHMEN

F8

Cadre / Frame / Rahmen	PVC
Profondeur des poches / Bag depth / Taschentiefe	525 - 635 mm
Média / Media / Media	Synthétique / Synthetic / Synthetisch
Classe de filtration / Class of filtration / Filterklasse	F8 (EN 779 : 2012)
Température / Temperature / Temperatur	80°C max.
Humidité relative / Relative humidity / Luftfeuchtigkeit	90 % max.
ΔP final recommended	450 Pa



N° Hifi	Dimensions / Abmessungen mm			Nombre de poches Number of bags Anzahl Taschen	Débit Flow Strom m³/h	ΔP initiale Initial ΔP Anfangs-ΔP Pa	Surface filtrante Filtering surface Filterierende Fläche m²
	B	H	P				
525 MM							
NX 509096DPA8	287	287	525	4	800	115	1.40
NX 509356DPA8	287	592	525	4	1700	115	2.60
NX 509516DPA8	287	892	525	4	2500	115	3.80
NX 518186EPA8	395	395	525	5	1400	115	2.50
NX 520356EPA8	402	592	525	5	2200	115	3.60
NX 520516EPA8	402	892	525	5	3200	115	5.20
NX 526266FPA8	492	492	525	6	2350	115	3.60
NX 526356FPA8	492	592	525	6	2700	115	4.00
NX 526516FPA8	492	892	525	6	4000	115	5.80
NX 535096HPA8	592	287	525	8	1700	115	2.90
NX 535206HPA8	592	402	525	8	2200	115	4.10
NX 535266HPA8	592	492	525	8	2800	115	4.50
NX 535356HPA8	592	592	525	8	3400	115	5.30
NX 535516HPA8	592	892	525	8	5000	115	7.70
NX 551096LPA8	892	287	525	12	2450	115	3.90
NX 551206LPA8	892	402	525	12	3200	115	5.10
NX 551266LPA8	892	492	525	12	3950	115	6.00
NX 551356LPA8	892	592	525	12	4950	115	7.10
635 MM							
NX 509097DPA8	287	287	635	4	800	105	1.80
NX 509357DPA8	287	592	635	4	1700	105	3.40
NX 509517DPA8	287	892	635	4	2600	105	4.90
NX 518187EPA8	395	395	635	5	1500	105	3.00
NX 520357EPA8	402	592	635	5	2350	105	4.20
NX 520517EPA8	402	892	635	5	3400	105	6.10
NX 526267FPA8	492	492	635	6	2500	105	4.30
NX 526357FPA8	492	592	635	6	2700	105	5.10
NX 526517FPA8	492	892	635	6	4200	105	7.30
NX 535097HPA8	592	287	635	8	1750	105	3.70
NX 535207HPA8	592	402	635	8	2350	105	4.90
NX 535267HPA8	592	492	635	8	2800	105	5.70
NX 535357HPA8	592	592	635	8	3400	105	6.60
NX 535517HPA8	592	892	635	8	5250	105	9.80
NX 551097LPA8	892	287	635	12	2600	105	4.60
NX 551207LPA8	892	402	635	12	3400	105	6.10
NX 551267LPA8	892	492	635	12	4200	105	7.20
NX 551357LPA8	892	592	635	12	5250	105	8.50



Autres dimensions sur demande.
Other dimensions on request.
Andere Abmessungen auf Anfrage.



FILTRES À PochES - CADRE PVC



POCKET FILTERS - PVC FRAME



TASCHENFILTER - PVC RAHMEN

F8

COURBES DE PERTE DE CHARGE | PRESSURE DROP CURVES | DRUCKABFALLKURVEN

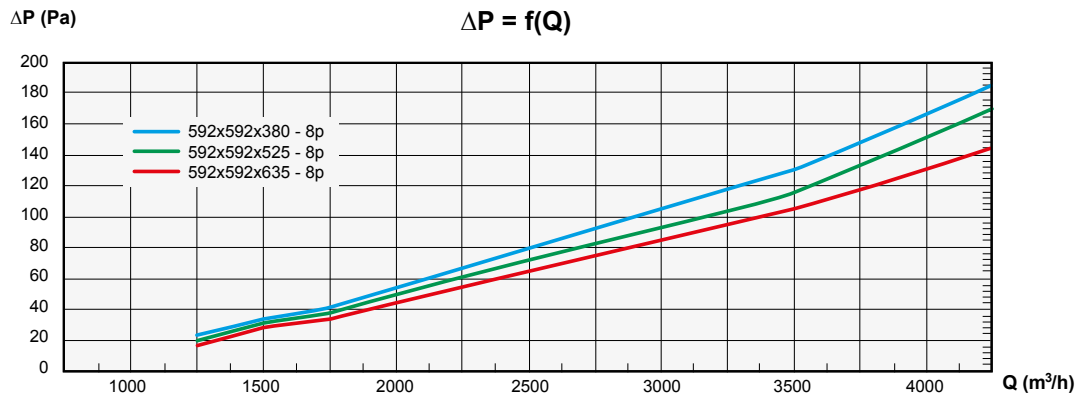



FILTRES À POCHE - CADRE PVC
POCKET FILTERS - PVC FRAME
TASCHENFILTER - PVC RAHMEN

F9

Cadre / Frame / Rahmen	PVC
Profondeur des poches / Bag depth / Taschentiefe	525 - 635 mm
Média / Media / Media	Synthétique / Synthetic / Synthetisch
Classe de filtration / Class of filtration / Filterklasse	F9 (EN 779 : 2012)
Température / Temperature / Temperatur	80°C max.
Humidité relative / Relative humidity / Luftfeuchtigkeit	90 % max.
ΔP final recommended	450 Pa

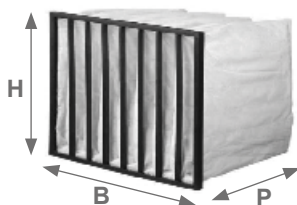

N° Hifi	Dimensions / Abmessungen mm			Nombre de poches Number of bags Anzahl Taschen	Débit Flow Strom m³/h	ΔP initiale Initial ΔP Anfangs-ΔP Pa	Surface filtrante Filtering surface Filterierende Fläche m²
	B	H	P				
525 MM							
NX 509096DPA9	287	287	525	4	800	145	1.40
NX 509356DPA9	287	592	525	4	1700	145	2.60
NX 509516DPA9	287	892	525	4	2500	145	3.80
NX 518186EPA9	395	395	525	5	1400	145	2.50
NX 520356EPA9	402	592	525	5	2200	145	3.60
NX 520516EPA9	402	892	525	5	3200	145	5.20
NX 526266FPA9	492	492	525	6	2350	145	3.60
NX 526356FPA9	492	592	525	6	2700	145	4.00
NX 526516FPA9	492	892	525	6	4000	145	5.80
NX 535096HPA9	592	287	525	8	1700	145	2.90
NX 535206HPA9	592	402	525	8	2200	145	4.10
NX 535266HPA9	592	492	525	8	2800	145	4.50
NX 535356HPA9	592	592	525	8	3400	145	5.30
NX 535516HPA9	592	892	525	8	5000	145	7.70
NX 551096LPA9	892	287	525	12	2450	145	3.90
NX 551206LPA9	892	402	525	12	3200	145	5.10
NX 551266LPA9	892	492	525	12	3950	145	6.00
NX 551356LPA9	892	592	525	12	4950	145	7.10
635 MM							
NX 509097DPA9	287	287	635	4	800	135	1.80
NX 509357DPA9	287	592	635	4	1700	135	3.40
NX 509517DPA9	287	892	635	4	2600	135	4.90
NX 518187EPA9	395	395	635	5	1500	135	3.00
NX 520357EPA9	402	592	635	5	2350	135	4.20
NX 520517EPA9	402	892	635	5	3400	135	6.10
NX 526267FPA9	492	492	635	6	2500	135	4.30
NX 526357FPA9	492	592	635	6	2700	135	5.10
NX 526517FPA9	492	892	635	6	4200	135	7.30
NX 535097HPA9	592	287	635	8	1750	135	3.70
NX 535207HPA9	592	402	635	8	2350	135	4.90
NX 535267HPA9	592	492	635	8	2800	135	5.70
NX 535357HPA9	592	592	635	8	3400	135	6.60
NX 535517HPA9	592	892	635	8	5250	135	9.80
NX 551097LPA9	892	287	635	12	2600	135	4.60
NX 551207LPA9	892	402	635	12	3400	135	6.10
NX 551267LPA9	892	492	635	12	4200	135	7.20
NX 551357LPA9	892	592	635	12	5250	135	8.50



Autres dimensions sur demande.
 Other dimensions on request.
 Andere Abmessungen auf Anfrage.



FILTRES À PochES - CADRE PVC



POCKET FILTERS - PVC FRAME



TASCHENFILTER - PVC RAHMEN

F9

COURBES DE PERTE DE CHARGE | PRESSURE DROP CURVES | DRUCKABFALLKURVEN

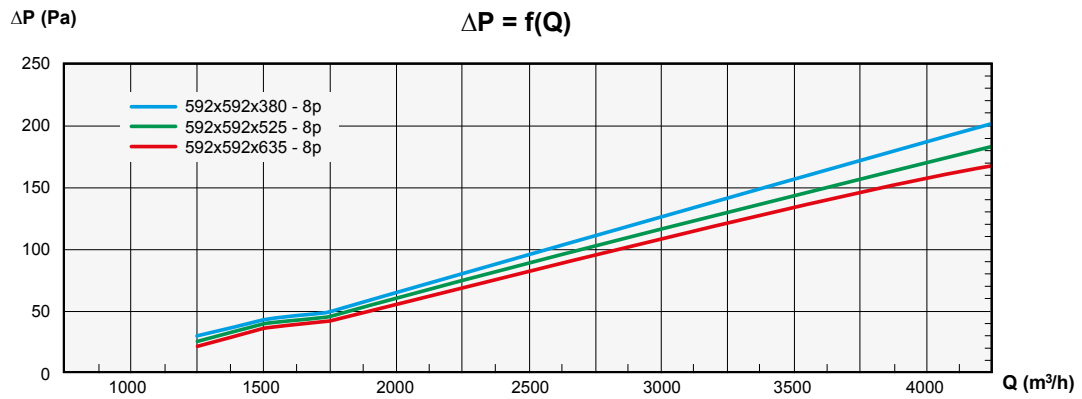



FILTRES À POCHE COMPACTES
COMPACT POCKET FILTERS
KOMPAKT-TASCHEFILTER

M5 - M6 - F7 - F8 - F9

Cadre / Frame / Rahmen	PVC
Profondeur des poches / Bag depth / Taschentiefe	292 mm
Média / Media / Media	Glass microfiber paper
Classe de filtration / Class of filtration / Filterklasse	M5 - M6 - F7 - F8 - F9 (EN 779 : 2012)
Température / Temperature / Temperatur	80°C max.
Humidité relative / Relative humidity / Luftfeuchtigkeit	95 % max.
ΔP final recommended	450 Pa

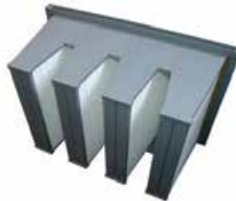

N° Hifi	Dimensions / Abmessungen mm			Débit Flow Strom m³/h	ΔP initiale Initial ΔP Anfangs-ΔP Pa	Surface filtrante Filtering surface Filterierende Fläche m²
	L	I	P			
M5						
NM 535093DPF5	592	287	292	2500	100	8.5
NM 535203DPF5	592	402	292	2900	100	12.5
NM 535263DPF5	592	492	292	4100	100	15
NM 535353DPF5	592	592	292	5000	100	18
M6						
NM 535093DPF6	592	287	292	2125	100	8.5
NM 535203DPF6	592	402	292	2900	100	12.5
NM 535263DPF6	592	492	292	3500	100	15
NM 535353DPF6	592	592	292	4250	100	18
F7						
NM 535093DPF7	592	287	292	2125	115	8.5
NM 535203DPF7	592	402	292	2900	115	12.5
NM 535263DPF7	592	492	292	3500	115	15
NM 535353DPF7	592	592	292	4250	115	18
F8						
NM 535093DPF8	592	287	292	2125	125	8.5
NM 535203DPF8	592	402	292	2900	125	12.5
NM 535263DPF8	592	492	292	3500	125	15
NM 535353DPF8	592	592	292	4250	125	18
F9						
NM 535093DPF9	592	287	292	2125	155	8.5
NM 535203DPF9	592	402	292	2900	155	12.5
NM 535263DPF9	592	492	292	3500	155	15
NM 535353DPF9	592	592	292	4250	155	18

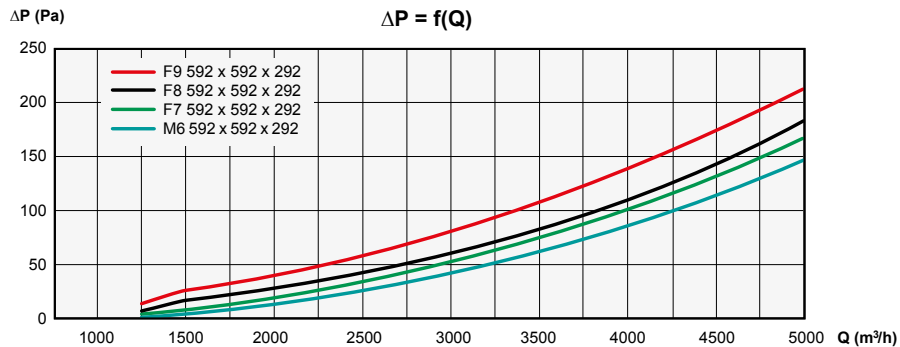

Autres dimensions sur demande.
 Other dimensions on request.
 Andere Abmessungen auf Anfrage.



FILTRES COMPACTES
COMPACT FILTERS
KOMPAKT-FILTER

F8 - F9

Cadre / Frame / Rahmen	Galvanisé ou PVC / Galvanized or PVC / Galvanisiertem oder PVC
Média / Media / Media	Glass microfiber paper
Classe de filtration / Class of filtration / Filterklasse	F8 - F9 (EN 779 : 2012)
Température / Temperature / Temperatur	80°C max.
Humidité relative / Relative humidity / Luftfeuchtigkeit	90 % max.
ΔP final recommended	450 Pa
Séparateurs / Separators / Trenner	Hotmelt

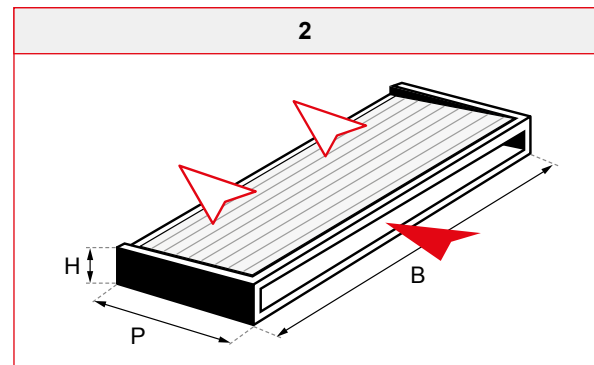
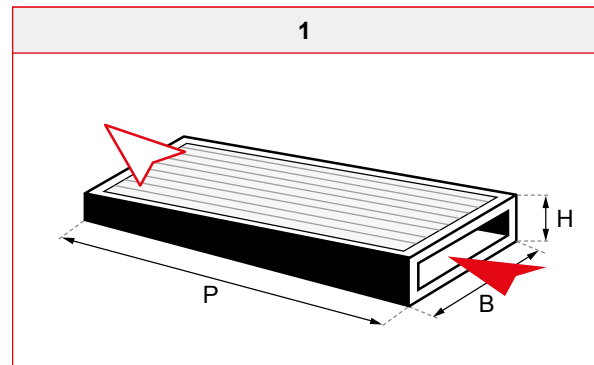
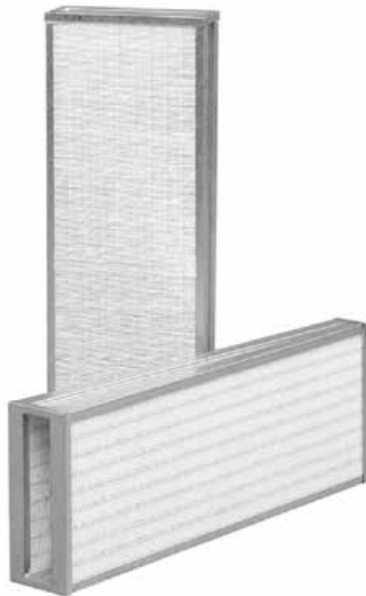

Type	N° Hifi	Dimensions / Abmessungen mm			Débit Flow Strom m³/h	ΔP initiale Initial ΔP Anfangs-ΔP Pa	Surface filtrante Filtering surface Filterierende Fläche m²	Cadre Frame Rahmen
		B	H	P				
F8								
1	NM 2307 S	202	87	600	200	90	3.40	Galva.
2	NM 2308 S	600	65	202	200	55	3.40	Galva.
F9								
1	NM 2309 S	202	87	600	200	125	3.40	PVC
2	NM 2310 S	600	65	202	200	70	3.40	PVC
1	NM 2389 S	202	87	400	135	120	2.30	Galva.



Autres dimensions sur demande.
 Other dimensions on request.
 Andere Abmessungen auf Anfrage.

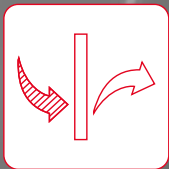

GAMME MOBILE

MOBILE PRODUCTS

PRODUKTE FÜR MOBILE GERÄTE

**Vous nous connaissez pour le matériel INDUSTRIE...
Cependant, avez-vous pensé à notre gamme MOBILE ?**



Vous avez peut-être un ou plusieurs véhicules à moteur, 4 ou 2 roues, un bateau, du matériel d'entretien d'espaces verts, de manutention, de travaux publics, agricole...
Nous pouvons vous apporter toutes les solutions complémentaires à vos approvisionnements en filtration. N'hésitez pas à nous consulter.

**You know about us because of our INDUSTRY range of products...
But have you ever thought about our MOBILE products?**



We also offer a full range of supplementary filtration supplies for your 2- or 4-wheeled motor vehicle, boat, green space or public works maintenance or agricultural equipment. Please do not hesitate to contact us for further information.

**Sie kennen uns wegen unserer INDUSTRIE-produkte...
Haben Sie jedoch schon an unsere Produkte für MOBILE Geräte gedacht?**



Sie besitzen vielleicht ein oder mehrere Motorfahrzeuge, 4 oder 2 Räder, ein Schiff, Geräte zur Pflege von Grünflächen, zur Beförderung, für öffentliche Bauarbeiten oder für die Landwirtschaft...
Wir bieten Ihnen alle für Ihre Filterausrüstung erforderlichen Zusatzlösungen. Zögern Sie nicht, sich an uns zu wenden.



Travaux publics
Construction equipment
Hoch- und Tiefbau



Automobile
Passenger cars
PKW



Marine
Marine
Schifffahrt



Manutention
Handling equipment
Gabelstapler und Hebetchnik



Agricole
Agriculture
Landwirtschaft



Espaces verts
Golf & Parks
Golf und Gartentechnik



Poids lourds / Bus
Trucks / Buses
LKW / Busse



Remontées mécaniques
Ski lifts
Skipistenbearbeitung



Motos - Quads
Motorcycles - ATV
Motorräder - Quads

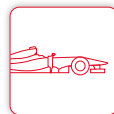

Hautes performances
High performance
Hochleistung



Vous souhaitez en savoir plus, nos équipes sont à votre écoute.
If you would like to know more, please contact one of our teams.
Für weitere Informationen wenden Sie sich bitte an unsere Mitarbeiter.

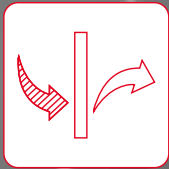

SOMMAIRE

CONTENTS

INHALTSVERZEICHNIS

AB
AC...

Codification
Codification
Legende

1 - 6

G

Préfiltre - Filtration gravimétrique
Prefilter - *Gravimetric filtration*
Vorfilter - *Gravimetrische Filtrierung*

7 - 28

F

Filtres fins - Filtration opacimétrique
Fine filter - *Opacimetric filtration*
Feinstaubfilter - *Opazimetrische Filtrierung*

29 - 48

H

Filtres absolus - Filtration absolue HEPA
Absolute filters - *Absolute HEPA filtration*
Schwebstoff-filter - *HEPA Schwebstofffilter*

49 - 64

CA
CAG

Adsorption - Filtres charbon actif
Adsorption - *Carbon filters*
Adsorbierung - *Aktivkohle-Filteractive*

65 - 68



Recommandations générales
General advices
Allgemeine Hinweise

Trucs et astuces
Tricks and clever bits
Tipps

Nos catalogues
Our catalogues
Unsere Kataloge

Conditions générales de vente
General terms of sales
Allgemeine Geschäftsbedingungen

69 - 80



FILTRES EPA-HEPA - CADRE ALUMINIUM (68 MM)
EPA-HEPA FILTERS - ALUMINIUM FRAME (68 MM)
FILTERS EPA-HEPA - ALUMINIUMRAHMEN (68 MM)

E10 - E11 - H13 - H14

Cadre / Frame / Rahmen	Aluminium
Épaisseur du cadre / Frame thickness / Rahmenseidigkeit	68 mm
Média / Media / Media	Glass microfiber paper
Classe de filtration / Class of filtration / Filterklasse	E10 - E11 - H13 - H14 (EN 1822)
Température / Temperature / Temperatur	70°C max.
Humidité relative / Relative humidity / Luftfeuchtigkeit	90 % max.
ΔP final recommended	500 Pa
Joint / Gasket / Dichtung	Polyurethane
Séparateurs / Separators / Trenner	Hotmelt



**Certified Performance
EN 1822**

N° Hifi	Dimensions / Abmessungen mm			Débit Flow Strom m³/h	ΔP initiale Initial ΔP Anfangs-ΔP Pa	Surface filtrante Filtering surface Filtrierende Fläche m²
	L	I	P			
E10						
NA 11313-H10A03	305	305	68	150	65	2.70
NA 17213-H10A04	457	305	68	225	65	4.10
NA 17272-H10A06	457	457	68	335	65	6.20
NA 13813-H10A06	610	305	68	300	65	5.50
NA 13872-H10A08	610	457	68	450	65	8.20
NA 13838-H10A11	610	610	68	600	65	11.00
NA 14613-H10A07	762	305	68	375	65	6.90
NA 14638-H10A14	762	610	68	750	65	13.70
NA 14646-H10A17	762	762	68	950	65	17.10
NA 15213-H10A08	915	305	68	450	65	8.20
NA 15238-H10A17	915	610	68	900	65	16.50
NA 15246-H10A21	915	762	68	1125	65	20.60
NA 15252-H10A25	915	915	68	1350	65	24.80
NA 16438-H10A22	1220	610	68	1200	65	22.00
NA 16446-H10A28	1220	762	68	1500	65	27.50
NA 16452-H10A33	1220	915	68	1800	65	33.00
NA 16738-H10A28	1524	610	68	1500	65	27.50
NA 16746-H10A34	1524	762	68	1875	65	34.40
NA 16752-H10A41	1524	915	68	2250	65	41.30
NA 16838-H10A33	1830	610	68	1800	65	33.00
NA 16846-H10A41	1830	762	68	2250	65	41.20
NA 16852-H10A50	1830	915	68	2700	65	49.50
E11						
NA 11313-H11A03	305	305	68	150	80	2.70
NA 17213-H11A04	457	305	68	225	80	4.10
NA 17272-H11A06	457	457	68	335	80	6.20
NA 13813-H11A06	610	305	68	300	80	5.50
NA 13872-H11A08	610	457	68	450	80	8.20
NA 13838-H11A11	610	610	68	600	80	11.00
NA 14613-H11A07	762	305	68	375	80	6.90
NA 14638-H11A14	762	610	68	750	80	13.70
NA 14646-H11A17	762	762	68	950	80	17.10
NA 15213-H11A08	915	305	68	450	80	8.20
NA 15238-H11A17	915	610	68	900	80	16.50
NA 15246-H11A21	915	762	68	1125	80	20.60
NA 15252-H11A25	915	915	68	1350	80	24.80
NA 16438-H11A22	1220	610	68	1200	80	22.00
NA 16446-H11A28	1220	762	68	1500	80	27.50
NA 16452-H11A33	1220	915	68	1800	80	33.00
NA 16738-H11A28	1524	610	68	1500	80	27.50
NA 16746-H11A34	1524	762	68	1875	80	34.40
NA 16752-H11A41	1524	915	68	2250	80	41.30
NA 16838-H11A33	1830	610	68	1800	80	33.00
NA 16846-H11A41	1830	762	68	2250	80	41.20
NA 16852-H11A50	1830	915	68	2700	80	49.50



FILTRES EPA-HEPA - CADRE ALUMINIUM (68 MM)
 EPA-HEPA FILTERS - ALUMINIUM FRAME (68 MM)
 FILTERS EPA-HEPA - ALUMINIUMRAHMEN (68 MM)

E10 - E11 - H13 - H14

N° Hifi	Dimensions / Abmessungen mm			Débit Flow Strom m³/h	ΔP initiale Initial ΔP Anfangs-ΔP Pa	Surface filtrante Filtering surface Filtrierende Fläche m²
	L	I	P			
H13						
NA 11313-H13A03	305	305	68	150	120	2.70
NA 17213-H13A04	457	305	68	225	120	4.10
NA 17272-H13A06	457	457	68	335	120	6.20
NA 13813-H13A06	610	305	68	300	120	5.50
NA 13872-H13A08	610	457	68	450	120	8.20
NA 13838-H13A11	610	610	68	600	120	11.00
NA 14613-H13A07	762	305	68	375	120	6.90
NA 14638-H13A14	762	610	68	750	120	13.70
NA 14646-H13A17	762	762	68	950	120	17.10
NA 15213-H13A08	915	305	68	450	120	8.20
NA 15238-H13A17	915	610	68	900	120	16.50
NA 15246-H13A21	915	762	68	1125	120	20.60
NA 15252-H13A25	915	915	68	1350	120	24.80
NA 16438-H13A22	1220	610	68	1200	120	22.00
NA 16446-H13A28	1220	762	68	1500	120	27.50
NA 16452-H13A33	1220	915	68	1800	120	33.00
NA 16738-H13A28	1524	610	68	1500	120	27.50
NA 16746-H13A34	1524	762	68	1875	120	34.40
NA 16752-H13A41	1524	915	68	2250	120	41.30
NA 16838-H13A33	1830	610	68	1800	120	33.00
NA 16846-H13A41	1830	762	68	2250	120	41.20
NA 16852-H13A50	1830	915	68	2700	120	49.50
H14						
NA 11313-H14A03	305	305	68	150	140	2.70
NA 17213-H14A04	457	305	68	225	140	4.10
NA 17272-H14A06	457	457	68	335	140	6.20
NA 13813-H14A06	610	305	68	300	140	5.50
NA 13872-H14A08	610	457	68	450	140	8.20
NA 13838-H14A11	610	610	68	600	140	11.00
NA 14613-H14A07	762	305	68	375	140	6.90
NA 14638-H14A14	762	610	68	750	140	13.70
NA 14646-H14A17	762	762	68	950	140	17.10
NA 15213-H14A08	915	305	68	450	140	8.20
NA 15238-H14A17	915	610	68	900	140	16.50
NA 15246-H14A21	915	762	68	1125	140	20.60
NA 15252-H14A25	915	915	68	1350	140	24.80
NA 16438-H14A22	1220	610	68	1200	140	22.00
NA 16446-H14A28	1220	762	68	1500	140	27.50
NA 16452-H14A33	1220	915	68	1800	140	33.00
NA 16738-H14A28	1524	610	68	1500	140	27.50
NA 16746-H14A34	1524	762	68	1875	140	34.40
NA 16752-H14A41	1524	915	68	2250	140	41.30
NA 16838-H14A33	1830	610	68	1800	140	33.00
NA 16846-H14A41	1830	762	68	2250	140	41.20
NA 16852-H14A50	1830	915	68	2700	140	49.50



Autres dimensions sur demande.
 Other dimensions on request.
 Andere Abmessungen auf Anfrage.



FILTRES EPA-HEPA - CADRE ALUMINIUM (80 MM)
EPA-HEPA FILTERS - ALUMINIUM FRAME (80 MM)
FILTERS EPA-HEPA - ALUMINIUMRAHMEN (80 MM)

E10 - E11 - H13 - H14

Cadre / Frame / Rahmen	Aluminium
Épaisseur du cadre / Frame thickness / Rahmenseidigkeit	80 mm
Média / Media / Media	Glass microfiber paper
Classe de filtration / Class of filtration / Filterklasse	E10 - E11 - H13 - H14 (EN 1822)
Température / Temperature / Temperatur	70°C max.
Humidité relative / Relative humidity / Luftfeuchtigkeit	90 % max.
ΔP final recommended	500 Pa
Joint / Gasket / Dichtung	Polyurethane
Séparateurs / Separators / Trenner	Hotmelt



**Certified Performance
EN 1822**

N° Hifi	Dimensions / Abmessungen mm			Débit Flow Strom m³/h	ΔP initiale Initial ΔP Anfangs-ΔP Pa	Surface filtrante Filtering surface Filtrierende Fläche m²
	L	I	P			
E10						
NA 21313-H10A03	305	305	80	150	55	2.90
NA 27213-H10A05	457	305	80	225	55	4.50
NA 27272-H10A07	457	457	80	335	55	6.70
NA 23813-H10A06	610	305	80	300	55	6.00
NA 23872-H10A09	610	457	80	450	55	9.00
NA 23838-H10A12	610	610	80	600	55	12.00
NA 24613-H10A08	762	305	80	375	55	7.50
NA 24638-H10A15	762	610	80	750	55	14.90
NA 24646-H10A19	762	762	80	950	55	18.60
NA 25213-H10A09	915	305	80	450	55	8.90
NA 25238-H10A18	915	610	80	900	55	18.00
NA 25246-H10A23	915	762	80	1125	55	22.50
NA 25252-H10A27	915	915	80	1350	55	27.00
NA 26438-H10A24	1220	610	80	1200	55	24.00
NA 26446-H10A30	1220	762	80	1500	55	30.00
NA 26452-H10A36	1220	915	80	1800	55	36.00
NA 26738-H10A30	1524	610	80	1500	55	30.00
NA 26746-H10A38	1524	762	80	1875	55	37.50
NA 26752-H10A45	1524	915	80	2250	55	45.00
NA 26838-H10A36	1830	610	80	1800	55	36.00
NA 26846-H10A45	1830	762	80	2250	55	45.00
NA 26852-H10A54	1830	915	80	2700	55	54.00
E11						
NA 21313-H11A03	305	305	80	150	60	2.90
NA 27213-H11A05	457	305	80	225	60	4.50
NA 27272-H11A07	457	457	80	335	60	6.70
NA 23813-H11A06	610	305	80	300	60	6.00
NA 23872-H11A09	610	457	80	450	60	9.00
NA 23838-H11A12	610	610	80	600	60	12.00
NA 24613-H11A08	762	305	80	375	60	7.50
NA 24638-H11A15	762	610	80	750	60	14.90
NA 24646-H11A19	762	762	80	950	60	18.60
NA 25213-H11A09	915	305	80	450	60	8.90
NA 25238-H11A18	915	610	80	900	60	18.00
NA 25246-H11A23	915	762	80	1125	60	22.50
NA 25252-H11A27	915	915	80	1350	60	27.00
NA 26438-H11A24	1220	610	80	1200	60	24.00
NA 26446-H11A30	1220	762	80	1500	60	30.00
NA 26452-H11A36	1220	915	80	1800	60	36.00
NA 26738-H11A30	1524	610	80	1500	60	30.00
NA 26746-H11A38	1524	762	80	1875	60	37.50
NA 26752-H11A45	1524	915	80	2250	60	45.00
NA 26838-H11A36	1830	610	80	1800	60	36.00
NA 26846-H11A45	1830	762	80	2250	60	45.00
NA 26852-H11A54	1830	915	80	2700	60	54.00



FILTRES EPA-HEPA - CADRE ALUMINIUM (80 MM)

EPA-HEPA FILTERS - ALUMINIUM FRAME (80 MM)

FILTERS EPA-HEPA - ALUMINIUMRAHMEN (80 MM)

E10 - E11 - H13 - H14

N° Hifi	Dimensions / Abmessungen mm			Débit Flow Strom m³/h	ΔP initiale Initial ΔP Anfangs-ΔP Pa	Surface filtrante Filtering surface Filtrierende Fläche m²
	L	I	P			
H13						
NA 21313-H13A03	305	305	80	150	90	2.90
NA 27213-H13A05	457	305	80	225	90	4.50
NA 27272-H13A07	457	457	80	335	90	6.70
NA 23813-H13A06	610	305	80	300	90	6.00
NA 23872-H13A09	610	457	80	450	90	9.00
NA 23838-H13A12	610	610	80	600	90	12.00
NA 24613-H13A08	762	305	80	375	90	7.50
NA 24638-H13A15	762	610	80	750	90	14.90
NA 24646-H13A19	762	762	80	950	90	18.60
NA 25213-H13A09	915	305	80	450	90	8.90
NA 25238-H13A18	915	610	80	900	90	18.00
NA 25246-H13A23	915	762	80	1125	90	22.50
NA 25252-H13A27	915	915	80	1350	90	27.00
NA 26438-H13A24	1220	610	80	1200	90	24.00
NA 26446-H13A30	1220	762	80	1500	90	30.00
NA 26452-H13A36	1220	915	80	1800	90	36.00
NA 26738-H13A30	1524	610	80	1500	90	30.00
NA 26746-H13A38	1524	762	80	1875	90	37.50
NA 26752-H13A45	1524	915	80	2250	90	45.00
NA 26838-H13A36	1830	610	80	1800	90	36.00
NA 26846-H13A45	1830	762	80	2250	90	45.00
NA 26852-H13A54	1830	915	80	2700	90	54.00
H14						
NA 21313-H14A03	305	305	80	150	100	2.90
NA 27213-H14A05	457	305	80	225	100	4.50
NA 27272-H14A07	457	457	80	335	100	6.70
NA 23813-H14A06	610	305	80	300	100	6.00
NA 23872-H14A09	610	457	80	450	100	9.00
NA 23838-H14A12	610	610	80	600	100	12.00
NA 24613-H14A08	762	305	80	375	100	7.50
NA 24638-H14A15	762	610	80	750	100	14.90
NA 24646-H14A19	762	762	80	950	100	18.60
NA 25213-H14A09	915	305	80	450	100	8.90
NA 25238-H14A18	915	610	80	900	100	18.00
NA 25246-H14A23	915	762	80	1125	100	22.50
NA 25252-H14A27	915	915	80	1350	100	27.00
NA 26438-H14A24	1220	610	80	1200	100	24.00
NA 26446-H14A30	1220	762	80	1500	100	30.00
NA 26452-H14A36	1220	915	80	1800	100	36.00
NA 26738-H14A30	1524	610	80	1500	100	30.00
NA 26746-H14A38	1524	762	80	1875	100	37.50
NA 26752-H14A45	1524	915	80	2250	100	45.00
NA 26838-H14A36	1830	610	80	1800	100	36.00
NA 26846-H14A45	1830	762	80	2250	100	45.00
NA 26852-H14A54	1830	915	80	2700	100	54.00



Autres dimensions sur demande.
Other dimensions on request.
Andere Abmessungen auf Anfrage.



FILTRES EPA-HEPA - CADRE ALUMINIUM (90 MM)
EPA-HEPA FILTERS - ALUMINIUM FRAME (90 MM)
FILTERS EPA-HEPA - ALUMINIUMRAHMEN (90 MM)

E10 - E11 - H13 - H14

Cadre / Frame / Rahmen	Aluminium
Épaisseur du cadre / Frame thickness / Rahmenseidke	90 mm
Média / Media / Media	Glass microfiber paper
Classe de filtration / Class of filtration / Filterklasse	E10 - E11 - H13 - H14 (EN 1822)
Température / Temperature / Temperatur	70°C max.
Humidité relative / Relative humidity / Luftfeuchtigkeit	90 % max.
ΔP final recommended	500 Pa
Joint / Gasket / Dichtung	Polyurethane
Séparateurs / Separators / Trenner	Hotmelt



**Certified Performance
EN 1822**

N° Hifi	Dimensions / Abmessungen mm			Débit Flow Strom m³/h	ΔP initiale Initial ΔP Anfangs-ΔP Pa	Surface filtrante Filtering surface Filtrierende Fläche m²
	L	I	P			
E10						
NA 31313-H10A03	305	305	90	150	50	3.50
NA 37213-H10A05	457	305	90	225	50	5.20
NA 37272-H10A08	457	457	90	335	50	7.80
NA 33813-H10A07	610	305	90	300	50	7.00
NA 33872-H10A10	610	457	90	450	50	10.40
NA 33838-H10A14	610	610	90	600	50	14.00
NA 34613-H10A09	762	305	90	375	50	8.80
NA 34638-H10A17	762	610	90	750	50	17.40
NA 34646-H10A22	762	762	90	950	50	21.70
NA 35213-H10A10	915	305	90	450	50	10.40
NA 35238-H10A21	915	610	90	900	50	21.00
NA 35246-H10A26	915	762	90	1125	50	26.20
NA 35252-H10A32	915	915	90	1350	50	31.50
NA 36438-H10A28	1220	610	90	1200	50	28.00
NA 36446-H10A35	1220	762	90	1500	50	35.00
NA 36452-H10A42	1220	915	90	1800	50	42.00
NA 36738-H10A35	1524	610	90	1500	50	35.00
NA 36746-H10A44	1524	762	90	1875	50	43.70
NA 36752-H10A53	1524	915	90	2250	50	52.50
NA 36838-H10A41	1830	610	90	1800	50	41.00
NA 36846-H10A52	1830	762	90	2250	50	52.30
NA 36852-H10A63	1830	915	90	2700	50	62.90
E11						
NA 31313-H11A03	305	305	90	150	55	3.50
NA 37213-H11A05	457	305	90	225	55	5.20
NA 37272-H11A08	457	457	90	335	55	7.80
NA 33813-H11A07	610	305	90	300	55	7.00
NA 33872-H11A10	610	457	90	450	55	10.40
NA 33838-H11A14	610	610	90	600	55	14.00
NA 34613-H11A09	762	305	90	375	55	8.80
NA 34638-H11A17	762	610	90	750	55	17.40
NA 34646-H11A22	762	762	90	950	55	21.70
NA 35213-H11A10	915	305	90	450	55	10.40
NA 35238-H11A21	915	610	90	900	55	21.00
NA 35246-H11A26	915	762	90	1125	55	26.20
NA 35252-H11A32	915	915	90	1350	55	31.50
NA 36438-H11A28	1220	610	90	1200	55	28.00
NA 36446-H11A35	1220	762	90	1500	55	35.00
NA 36452-H11A42	1220	915	90	1800	55	42.00
NA 36738-H11A35	1524	610	90	1500	55	35.00
NA 36746-H11A44	1524	762	90	1875	55	43.70
NA 36752-H11A53	1524	915	90	2250	55	52.50
NA 36838-H11A41	1830	610	90	1800	55	41.00
NA 36846-H11A52	1830	762	90	2250	55	52.30
NA 36852-H11A63	1830	915	90	2700	55	62.90



FILTRES EPA-HEPA - CADRE ALUMINIUM (90 MM)
EPA-HEPA FILTERS - ALUMINIUM FRAME (90 MM)
FILTERS EPA-HEPA - ALUMINIUMRAHMEN (90 MM)

E10 - E11 - H13 - H14

N° Hifi	Dimensions / Abmessungen mm			Débit Flow Strom m³/h	ΔP initiale Initial ΔP Anfangs-ΔP Pa	Surface filtrante Filtering surface Filtrierende Fläche m²
	L	I	P			
H13						
NA 31313-H13A03	305	305	90	150	80	3.50
NA 37213-H13A05	457	305	90	225	80	5.20
NA 37272-H13A08	457	457	90	335	80	7.80
NA 33813-H13A07	610	305	90	300	80	7.00
NA 33872-H13A10	610	457	90	450	80	10.40
NA 33838-H13A14	610	610	90	600	80	14.00
NA 34613-H13A09	762	305	90	375	80	8.80
NA 34638-H13A17	762	610	90	750	80	17.40
NA 34646-H13A22	762	762	90	950	80	21.70
NA 35213-H13A10	915	305	90	450	80	10.40
NA 35238-H13A21	915	610	90	900	80	21.00
NA 35246-H13A26	915	762	90	1125	80	26.20
NA 35252-H13A32	915	915	90	1350	80	31.50
NA 36438-H13A28	1220	610	90	1200	80	28.00
NA 36446-H13A35	1220	762	90	1500	80	35.00
NA 36452-H13A42	1220	915	90	1800	80	42.00
NA 36738-H13A35	1524	610	90	1500	80	35.00
NA 36746-H13A44	1524	762	90	1875	80	43.70
NA 36752-H13A53	1524	915	90	2250	80	52.50
NA 36838-H13A41	1830	610	90	1800	80	41.00
NA 36846-H13A52	1830	762	90	2250	80	52.30
NA 36852-H13A63	1830	915	90	2700	80	62.90
H14						
NA 31313-H14A03	305	305	90	150	90	3.50
NA 37213-H14A05	457	305	90	225	90	5.20
NA 37272-H14A08	457	457	90	335	90	7.80
NA 33813-H14A07	610	305	90	300	90	7.00
NA 33872-H14A10	610	457	90	450	90	10.40
NA 33838-H14A14	610	610	90	600	90	14.00
NA 34613-H14A09	762	305	90	375	90	8.80
NA 34638-H14A17	762	610	90	750	90	17.40
NA 34646-H14A22	762	762	90	950	90	21.70
NA 35213-H14A10	915	305	90	450	90	10.40
NA 35238-H14A21	915	610	90	900	90	21.00
NA 35246-H14A26	915	762	90	1125	90	26.20
NA 35252-H14A32	915	915	90	1350	90	31.50
NA 36438-H14A28	1220	610	90	1200	90	28.00
NA 36446-H14A35	1220	762	90	1500	90	35.00
NA 36452-H14A42	1220	915	90	1800	90	42.00
NA 36738-H14A35	1524	610	90	1500	90	35.00
NA 36746-H14A44	1524	762	90	1875	90	43.70
NA 36752-H14A53	1524	915	90	2250	90	52.50
NA 36838-H14A41	1830	610	90	1800	90	41.00
NA 36846-H14A52	1830	762	90	2250	90	52.30
NA 36852-H14A63	1830	915	90	2700	90	62.90



Autres dimensions sur demande.
 Other dimensions on request.
 Andere Abmessungen auf Anfrage.



FILTRES EPA-HEPA - CADRE ALUMINIUM (150 MM)

EPA-HEPA FILTERS - ALUMINIUM FRAME (150 MM)

FILTERS EPA-HEPA - ALUMINIUMRAHMEN (150 MM)

E10 - E11 - H13 - H14

Cadre / Frame / Rahmen	Aluminium
Épaisseur du cadre / Frame thickness / Rahmendicke	150 mm
Média / Media / Media	Glass microfiber paper
Classe de filtration / Class of filtration / Filterklasse	E10 - E11 - H13 - H14 (EN 1822)
Température / Temperature / Temperatur	70°C max.
Humidité relative / Relative humidity / Luftfeuchtigkeit	90 % max.
ΔP final recommended	500 Pa
Joint / Gasket / Dichtung	Polyurethane
Séparateurs / Separators / Trenner	Hotmelt



**Certified Performance
EN 1822**

N° Hifi	Dimensions / Abmessungen mm			Débit Flow Strom m ³ /h	ΔP initiale Initial ΔP Anfangs-ΔP Pa	Surface filtrante Filtering surface Filtrierende Fläche m ²
	L	I	P			
E10						
NA 41313-H10A03	305	305	150	150	65	2.70
NA 47213-H10A05	457	305	150	225	65	4.10
NA 47272-H10A06	457	457	150	335	65	6.20
NA 43813-H10A06	610	305	150	300	65	5.50
NA 43872-H10A08	610	457	150	450	65	8.20
NA 43838-H10A11	610	610	150	600	65	11.00
NA 44613-H10A07	762	305	150	375	65	6.90
NA 44638-H10A14	762	610	150	750	65	13.70
NA 44646-H10A17	762	762	150	950	65	17.10
NA 45213-H10A08	915	305	150	450	65	8.20
NA 45238-H10A17	915	610	150	900	65	16.50
NA 45246-H10A21	915	762	150	1125	65	20.60
NA 45252-H10A25	915	915	150	1350	65	24.80
NA 46438-H10A22	1220	610	150	1200	65	22.00
NA 46446-H10A28	1220	762	150	1500	65	27.50
NA 46452-H10A33	1220	915	150	1800	65	33.00
NA 46738-H10A28	1524	610	150	1500	65	27.50
NA 46746-H10A34	1524	762	150	1875	65	34.40
NA 46752-H10A41	1524	915	150	2250	65	24.80
NA 46838-H10A33	1830	610	150	1800	65	33.00
NA 46846-H10A41	1830	762	150	2250	65	41.20
NA 46852-H10A50	1830	915	150	2700	65	49.50
E11						
NA 41313-H11A03	305	305	150	150	80	2.70
NA 47213-H11A05	457	305	150	225	80	4.10
NA 47272-H11A06	457	457	150	335	80	6.20
NA 43813-H11A06	610	305	150	300	80	5.50
NA 43872-H11A08	610	457	150	450	80	8.20
NA 43838-H11A11	610	610	150	600	80	11.00
NA 44613-H11A07	762	305	150	375	80	6.90
NA 44638-H11A14	762	610	150	750	80	13.70
NA 44646-H11A17	762	762	150	950	80	17.10
NA 45213-H11A08	915	305	150	450	80	8.20
NA 45238-H11A17	915	610	150	900	80	16.50
NA 45246-H11A21	915	762	150	1125	80	20.60
NA 45252-H11A25	915	915	150	1350	80	24.80
NA 46438-H11A22	1220	610	150	1200	80	22.00
NA 46446-H11A28	1220	762	150	1500	80	27.50
NA 46452-H11A33	1220	915	150	1800	80	33.00
NA 46738-H11A28	1524	610	150	1500	80	27.50
NA 46746-H11A34	1524	762	150	1875	80	34.40
NA 46752-H11A41	1524	915	150	2250	80	24.80
NA 46838-H11A33	1830	610	150	1800	80	33.00
NA 46846-H11A41	1830	762	150	2250	80	41.20
NA 46852-H11A50	1830	915	150	2700	80	49.50



FILTRES EPA-HEPA - CADRE ALUMINIUM (150 MM)

EPA-HEPA FILTERS - ALUMINIUM FRAME (150 MM)

FILTERS EPA-HEPA - ALUMINIUMRAHMEN (150 MM)

E10 - E11 - H13 - H14

N° Hifi	Dimensions / Abmessungen mm			Débit Flow Strom m ³ /h	ΔP initiale Initial ΔP Anfangs-ΔP Pa	Surface filtrante Filtering surface Filtrierende Fläche m ²
	L	I	P			
H13						
NA 41313-H13A03	305	305	150	150	120	2.70
NA 47213-H13A05	457	305	150	225	120	4.10
NA 47272-H13A06	457	457	150	335	120	6.20
NA 43813-H13A06	610	305	150	300	120	5.50
NA 43872-H13A08	610	457	150	450	120	8.20
NA 43838-H13A11	610	610	150	600	120	11.00
NA 44613-H13A07	762	305	150	375	120	6.90
NA 44638-H13A14	762	610	150	750	120	13.70
NA 44646-H13A17	762	762	150	950	120	17.10
NA 45213-H13A08	915	305	150	450	120	8.20
NA 45238-H13A17	915	610	150	900	120	16.50
NA 45246-H13A21	915	762	150	1125	120	20.60
NA 45252-H13A25	915	915	150	1350	120	24.80
NA 46438-H13A22	1220	610	150	1200	120	22.00
NA 46446-H13A28	1220	762	150	1500	120	27.50
NA 46452-H13A33	1220	915	150	1800	120	33.00
NA 46738-H13A28	1524	610	150	1500	120	27.50
NA 46746-H13A34	1524	762	150	1875	120	34.40
NA 46752-H13A41	1524	915	150	2250	120	24.80
NA 46838-H13A33	1830	610	150	1800	120	33.00
NA 46846-H13A41	1830	762	150	2250	120	41.20
NA 46852-H13A50	1830	915	150	2700	120	49.50
H14						
NA 41313-H14A03	305	305	150	150	140	2.70
NA 47213-H14A05	457	305	150	225	140	4.10
NA 47272-H14A06	457	457	150	335	140	6.20
NA 43813-H14A06	610	305	150	300	140	5.50
NA 43872-H14A08	610	457	150	450	140	8.20
NA 43838-H14A11	610	610	150	600	140	11.00
NA 44613-H14A07	762	305	150	375	140	6.90
NA 44638-H14A14	762	610	150	750	140	13.70
NA 44646-H14A17	762	762	150	950	140	17.10
NA 45213-H14A08	915	305	150	450	140	8.20
NA 45238-H14A17	915	610	150	900	140	16.50
NA 45246-H14A21	915	762	150	1125	140	20.60
NA 45252-H14A25	915	915	150	1350	140	24.80
NA 46438-H14A22	1220	610	150	1200	140	22.00
NA 46446-H14A28	1220	762	150	1500	140	27.50
NA 46452-H14A33	1220	915	150	1800	140	33.00
NA 46738-H14A28	1524	610	150	1500	140	27.50
NA 46746-H14A34	1524	762	150	1875	140	34.40
NA 46752-H14A41	1524	915	150	2250	140	24.80
NA 46838-H14A33	1830	610	150	1800	140	33.00
NA 46846-H14A41	1830	762	150	2250	140	41.20
NA 46852-H14A50	1830	915	150	2700	140	49.50



Autres dimensions sur demande.
Other dimensions on request.
Andere Abmessungen auf Anfrage.



FILTRES EPA-HEPA - CADRE MDF (150 MM)

EPA-HEPA FILTERS - MDF FRAME (150 MM)

FILTERS EPA-HEPA - MDF HOLZRAHMEN (150 MM)

E10 - E11 - H13 - H14

Cadre / Frame / Rahmen	MDF
Épaisseur du cadre / Frame thickness / Rahmenseidke	150 mm
Média / Media / Media	Glass microfiber paper
Classe de filtration / Class of filtration / Filterklasse	E10 - E11 - H13 - H14 (EN 1822)
Température / Temperature / Temperatur	70°C max.
Humidité relative / Relative humidity / Luftfeuchtigkeit	90 % max.
ΔP final recommended	500 Pa
Joint / Gasket / Dichtung	Polyurethane
Séparateurs / Separators / Trenner	Aluminium



**Certified Performance
EN 1822**

N° Hifi	Dimensions / Abmessungen mm			Débit Flow Strom m ³ /h	ΔP initiale Initial ΔP Anfangs-ΔP Pa	Surface filtrante Filtering surface Filtrierende Fläche m ²
	L	I	P			
E10						
NA 41313-H10B03	305	305	150	150	65	2.70
NA 47213-H10B05	457	305	150	225	65	4.10
NA 47272-H10B06	457	457	150	335	65	6.20
NA 43813-H10B06	610	305	150	300	65	5.50
NA 43872-H10B08	610	457	150	450	65	8.20
NA 43838-H10B11	610	610	150	600	65	11.00
NA 44613-H10B07	762	305	150	375	65	6.90
NA 44638-H10B14	762	610	150	750	65	13.70
NA 44646-H10B17	762	762	150	950	65	17.10
NA 45213-H10B08	915	305	150	450	65	8.20
NA 45238-H10B17	915	610	150	900	65	16.50
NA 45246-H10B21	915	762	150	1125	65	20.60
NA 45252-H10B25	915	915	150	1350	65	24.80
NA 46438-H10B22	1220	610	150	1200	65	22.00
NA 46446-H10B28	1220	762	150	1500	65	27.50
NA 46452-H10B33	1220	915	150	1800	65	33.00
NA 46738-H10B28	1524	610	150	1500	65	27.50
NA 46746-H10B34	1524	762	150	1875	65	34.40
NA 46752-H10B41	1524	915	150	2250	65	24.80
NA 46838-H10B33	1830	610	150	1800	65	33.00
NA 46846-H10B41	1830	762	150	2250	65	41.20
NA 46852-H10B50	1830	915	150	2700	65	49.50
E11						
NA 41313-H11B03	305	305	150	150	80	2.70
NA 47213-H11B05	457	305	150	225	80	4.10
NA 47272-H11B06	457	457	150	335	80	6.20
NA 43813-H11B06	610	305	150	300	80	5.50
NA 43872-H11B08	610	457	150	450	80	8.20
NA 43838-H11B11	610	610	150	600	80	11.00
NA 44613-H11B07	762	305	150	375	80	6.90
NA 44638-H11B14	762	610	150	750	80	13.70
NA 44646-H11B17	762	762	150	950	80	17.10
NA 45213-H11B08	915	305	150	450	80	8.20
NA 45238-H11B17	915	610	150	900	80	16.50
NA 45246-H11B21	915	762	150	1125	80	20.60
NA 45252-H11B25	915	915	150	1350	80	24.80
NA 46438-H11B22	1220	610	150	1200	80	22.00
NA 46446-H11B28	1220	762	150	1500	80	27.50
NA 46452-H11B33	1220	915	150	1800	80	33.00
NA 46738-H11B28	1524	610	150	1500	80	27.50
NA 46746-H11B34	1524	762	150	1875	80	34.40
NA 46752-H11B41	1524	915	150	2250	80	24.80
NA 46838-H11B33	1830	610	150	1800	80	33.00
NA 46846-H11B41	1830	762	150	2250	80	41.20
NA 46852-H11B50	1830	915	150	2700	80	49.50



FILTRES EPA-HEPA - CADRE MDF (150 MM)

EPA-HEPA FILTERS - MDF FRAME (150 MM)

FILTERS EPA-HEPA - MDF HOLZRAHMEN (150 MM)

E10 - E11 - H13 - H14

N° Hifi	Dimensions / Abmessungen mm			Débit Flow Strom m³/h	ΔP initiale Initial ΔP Anfangs-ΔP Pa	Surface filtrante Filtering surface Filtrierende Fläche m²
	L	I	P			
H13						
NA 41313-H13B03	305	305	150	150	120	2.70
NA 47213-H13B05	457	305	150	225	120	4.10
NA 47272-H13B06	457	457	150	335	120	6.20
NA 43813-H13B06	610	305	150	300	120	5.50
NA 43872-H13B08	610	457	150	450	120	8.20
NA 43838-H13B11	610	610	150	600	120	11.00
NA 44613-H13B07	762	305	150	375	120	6.90
NA 44638-H13B14	762	610	150	750	120	13.70
NA 44646-H13B17	762	762	150	950	120	17.10
NA 45213-H13B08	915	305	150	450	120	8.20
NA 45238-H13B17	915	610	150	900	120	16.50
NA 45246-H13B21	915	762	150	1125	120	20.60
NA 45252-H13B25	915	915	150	1350	120	24.80
NA 46438-H13B22	1220	610	150	1200	120	22.00
NA 46446-H13B28	1220	762	150	1500	120	27.50
NA 46452-H13B33	1220	915	150	1800	120	33.00
NA 46738-H13B28	1524	610	150	1500	120	27.50
NA 46746-H13B34	1524	762	150	1875	120	34.40
NA 46752-H13B41	1524	915	150	2250	120	24.80
NA 46838-H13B33	1830	610	150	1800	120	33.00
NA 46846-H13B41	1830	762	150	2250	120	41.20
NA 46852-H13B50	1830	915	150	2700	120	49.50
H14						
NA 41313-H14B03	305	305	150	150	140	2.70
NA 47213-H14B05	457	305	150	225	140	4.10
NA 47272-H14B06	457	457	150	335	140	6.20
NA 43813-H14B06	610	305	150	300	140	5.50
NA 43872-H14B08	610	457	150	450	140	8.20
NA 43838-H14B11	610	610	150	600	140	11.00
NA 44613-H14B07	762	305	150	375	140	6.90
NA 44638-H14B14	762	610	150	750	140	13.70
NA 44646-H14B17	762	762	150	950	140	17.10
NA 45213-H14B08	915	305	150	450	140	8.20
NA 45238-H14B17	915	610	150	900	140	16.50
NA 45246-H14B21	915	762	150	1125	140	20.60
NA 45252-H14B25	915	915	150	1350	140	24.80
NA 46438-H14B22	1220	610	150	1200	140	22.00
NA 46446-H14B28	1220	762	150	1500	140	27.50
NA 46452-H14B33	1220	915	150	1800	140	33.00
NA 46738-H14B28	1524	610	150	1500	140	27.50
NA 46746-H14B34	1524	762	150	1875	140	34.40
NA 46752-H14B41	1524	915	150	2250	140	24.80
NA 46838-H14B33	1830	610	150	1800	140	33.00
NA 46846-H14B41	1830	762	150	2250	140	41.20
NA 46852-H14B50	1830	915	150	2700	140	49.50



Autres dimensions sur demande.
Other dimensions on request.
Andere Abmessungen auf Anfrage.



FILTRES EPA-HEPA - CADRE MDF (292 MM)

EPA-HEPA FILTERS - MDF FRAME (292 MM)

FILTERS EPA-HEPA - MDF HOLZRAHMEN (292 MM)

E10 - E11 - H13 - H14

Cadre / Frame / Rahmen	MDF
Épaisseur du cadre / Frame thickness / Rahmenseidke	292 mm
Média / Media / Media	Glass microfiber paper
Classe de filtration / Class of filtration / Filterklasse	E10 - E11 - H13 - H14 (EN 1822)
Température / Temperature / Temperatur	70°C max.
Humidité relative / Relative humidity / Luftfeuchtigkeit	90 % max.
ΔP final recommended	500 Pa
Joint / Gasket / Dichtung	Polyurethane
Séparateurs / Separators / Trenner	Aluminium



**Certified Performance
EN 1822**

N° Hifi	Dimensions / Abmessungen mm			Débit Flow Strom m³/h	ΔP initiale Initial ΔP Anfangs-ΔP Pa	Surface filtrante Filtering surface Filterierende Fläche m²
	L	I	P			
E10						
NA 71313-H10B04	305	305	292	500	125	4.6
NA 77272-H10B11	457	457	292	1200	125	10.5
NA 73509-H10B09	592	287	292	1000	125	8.5
NA 73535-H10B19	592	592	292	2000	125	18.9
NA 73813-H10B09	610	305	292	1000	125	9.4
NA 73872-H10B15	610	457	292	1500	125	14.7
NA 73838-H10B21	610	610	292	2000	125	20.5
NA 74638-H10B26	762	610	292	2500	125	25.6
E11						
NA 71313-H11B04	305	305	292	500	140	4.6
NA 77272-H11B11	457	457	292	1200	140	10.5
NA 73509-H11B09	592	287	292	1000	140	8.5
NA 73535-H11B19	592	592	292	2000	140	18.9
NA 73813-H11B09	610	305	292	1000	140	9.4
NA 73872-H11B15	610	457	292	1500	140	14.7
NA 73838-H11B21	610	610	292	2000	140	20.5
NA 74638-H11B26	762	610	292	2500	140	25.6
H13						
NA 71313-H13B04	305	305	292	500	250	4.6
NA 77272-H13B11	457	457	292	1200	250	10.5
NA 73509-H13B09	592	287	292	1000	250	8.5
NA 73535-H13B19	592	592	292	2000	250	18.9
NA 73813-H13B09	610	305	292	1000	250	9.4
NA 73872-H13B15	610	457	292	1500	250	14.7
NA 73838-H13B21	610	610	292	2000	250	20.5
NA 74638-H13B26	762	610	292	2500	250	25.6
H14						
NA 71313-H14B04	305	305	292	500	280	4.6
NA 77272-H14B11	457	457	292	1200	280	10.5
NA 73509-H14B09	592	287	292	1000	280	8.5
NA 73535-H14B19	592	592	292	2000	280	18.9
NA 73813-H14B09	610	305	292	1000	280	9.4
NA 73872-H14B15	610	457	292	1500	280	14.7
NA 73838-H14B21	610	610	292	2000	280	20.5
NA 74638-H14B26	762	610	292	2500	280	25.6



Autres dimensions sur demande.
Other dimensions on request.
Andere Abmessungen auf Anfrage.



FILTRES EPA-HEPA - CADRE GALVANISÉ (292 MM)

EPA-HEPA FILTERS - GALVANIZED FRAME (292 MM)

FILTERS EPA-HEPA - GALVANISIERTEM RAHMEN (292 MM)

E10 - E11 - H13 - H14

Cadre / Frame / Rahmen	Acier galvanisé / Galvanised steel / Stahl verzinkt
Épaisseur du cadre / Frame thickness / Rahmenseidte	292 mm
Média / Media / Media	Glass microfiber paper
Classe de filtration / Class of filtration / Filterklasse	E10 - E11 - H13 - H14 (EN 1822)
Température / Temperature / Temperatur	70°C max.
Humidité relative / Relative humidity / Luftfeuchtigkeit	90 % max.
ΔP final recommended	500 Pa
Joint / Gasket / Dichtung	Polyurethane
Séparateurs / Separators / Trenner	Thermoplastiques / Thermoplastic



**Certified Performance
EN 1822**

N° Hifi	Dimensions / Abmessungen mm			Débit Flow Strom m ³ /h	ΔP initiale Initial ΔP Anfangs-ΔP Pa	Surface filtrante Filtering surface Filtrierende Fläche m ²
	L	I	P			
E10						
ND 71313-H10G09	305	305	292	900	125	9
ND 71313-H10G10	305	305	292	1000	125	10
ND 73813-H10G19	610	305	292	1750	125	19
ND 73813-H10G21	610	305	292	2000	125	21
ND 73872-H10G28	610	457	292	2250	125	28
ND 73872-H10G31	610	457	292	3000	125	31
ND 73838-H10G38	610	610	292	3750	125	38
ND 73838-H10G42	610	610	292	4000	125	42
ND 74638-H10G47	762	610	292	4250	125	47
ND 74638-H10G52	762	610	292	5000	125	52
E11						
ND 71313-H11G09	305	305	292	900	140	9
ND 71313-H11G10	305	305	292	1000	140	10
ND 73813-H11G19	610	305	292	1750	140	19
ND 73813-H11G21	610	305	292	2000	140	21
ND 73872-H11G28	610	457	292	2250	140	28
ND 73872-H11G31	610	457	292	3000	140	31
ND 73838-H11G38	610	610	292	3750	140	38
ND 73838-H11G42	610	610	292	4000	140	42
ND 74638-H11G47	762	610	292	4250	140	47
ND 74638-H11G52	762	610	292	5000	140	52
H13						
ND 71313-H13G09	305	305	292	900	250	9
ND 71313-H13G10	305	305	292	1000	250	10
ND 73813-H13G19	610	305	292	1750	250	19
ND 73813-H13G21	610	305	292	2000	250	21
ND 73872-H13G28	610	457	292	2250	250	28
ND 73872-H13G31	610	457	292	3000	250	31
ND 73838-H13G38	610	610	292	3750	250	38
ND 73838-H13G42	610	610	292	4000	250	42
ND 74638-H13G47	762	610	292	4250	250	47
ND 74638-H13G52	762	610	292	5000	250	52
H14						
ND 71313-H14G09	305	305	292	900	280	9
ND 71313-H14G10	305	305	292	1000	280	10
ND 73813-H14G19	610	305	292	1750	280	19
ND 73813-H14G21	610	305	292	2000	280	21
ND 73872-H14G28	610	457	292	2250	280	28
ND 73872-H14G31	610	457	292	3000	280	31
ND 73838-H14G38	610	610	292	3750	280	38
ND 73838-H14G42	610	610	292	4000	280	42
ND 74638-H14G47	762	610	292	4250	280	47
ND 74638-H14G52	762	610	292	5000	280	52



Autres dimensions sur demande.
Other dimensions on request.
Andere Abmessungen auf Anfrage.



FILTRES À POCHE COMPACTES - EPA-HEPA (292 MM)
COMPACT POCKET FILTERS - EPA-HEPA (292 MM)
KOMPAKT-TASCHEFILTER - EPA-HEPA (292 MM)

E10 - E11 - E12 - H13

Cadre / Frame / Rahmen	PVC
Profondeur des poches / Bag depth / Taschentiefe	292 mm
Média / Media / Media	Glass microfiber paper
Classe de filtration / Class of filtration / Filterklasse	E10 - E11 - E12 - H13 (EN 1822)
Température / Temperature / Temperatur	65°C max.
Humidité relative / Relative humidity / Luftfeuchtigkeit	90 % max.
ΔP final recommended	500 Pa

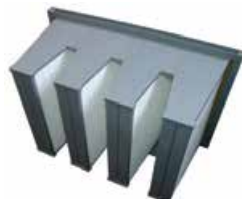

**Certified Performance
EN 1822**

N° Hifi	Dimensions / Abmessungen mm			Débit Flow Strom m³/h	ΔP initiale Initial ΔP Anfangs-ΔP Pa	Surface filtrante Filtering surface Filterierende Fläche m²
	L	I	P			
E10						
NM 535093DPH10	592	287	292	1700	170	8.5
NM 535203DPH10	592	402	292	2300	170	11.5
NM 535263DPH10	592	492	292	2800	170	15
NM 535353DPH10	592	592	292	3400	170	18
E11						
NM 535093DPH11	592	287	292	1700	200	8.5
NM 535203DPH11	592	402	292	2300	200	11.5
NM 535263DPH11	592	492	292	2800	200	15
NM 535353DPH11	592	592	292	3400	200	18
E12						
NM 535093DPH12	592	287	292	1250	240	8.5
NM 535203DPH12	592	402	292	1700	240	11.5
NM 535263DPH12	592	492	292	2100	240	15
NM 535353DPH12	592	592	292	2500	240	18
H13						
NM 535093DPH13	592	287	292	1250	280	8.5
NM 535203DPH13	592	402	292	1700	280	11.5
NM 535263DPH13	592	492	292	2100	280	15
NM 535353DPH13	592	592	292	2500	280	18

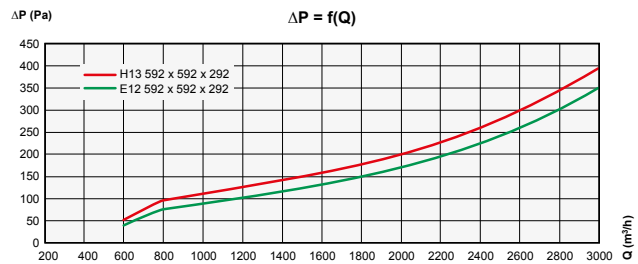
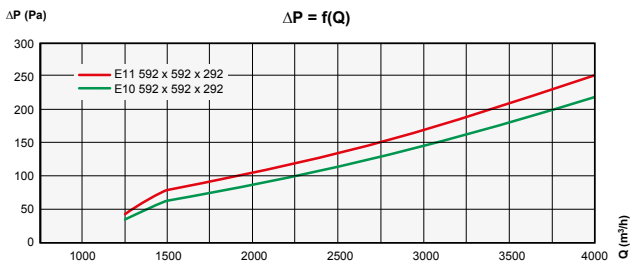

Autres dimensions sur demande.
 Other dimensions on request.
 Andere Abmessungen auf Anfrage.



FILTRES COMPACTES EPA-HEPA
EPA-HEPA COMPACT FILTERS
KOMPAKT-FILTER EPA-HEPA

E10 - E12 - H13

Cadre / Frame / Rahmen	Galvanisé ou PVC / Galvanized or PVC / Galvanisiertem oder PVC
Média / Media / Media	Glass microfiber paper
Classe de filtration / Class of filtration / Filterklasse	E10 - E12 - H13 (EN 779 : 2012)
Température / Temperature / Temperatur	80°C max.
Humidité relative / Relative humidity / Luftfeuchtigkeit	90 % max.
ΔP final recommended	450 Pa
Séparateurs / Separators / Trenner	Hotmelt

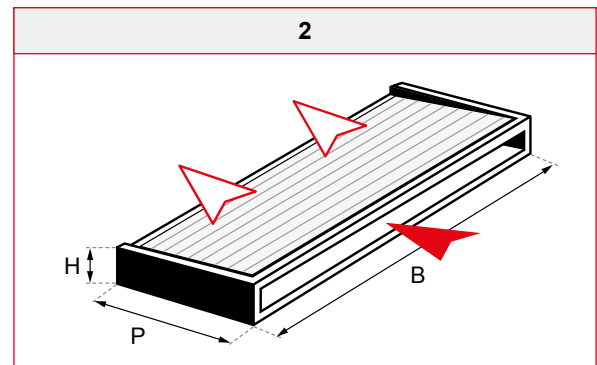
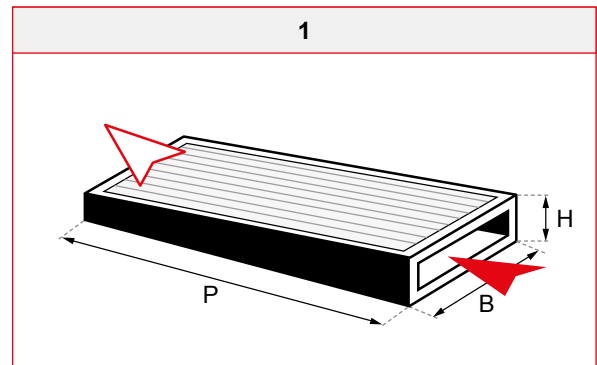
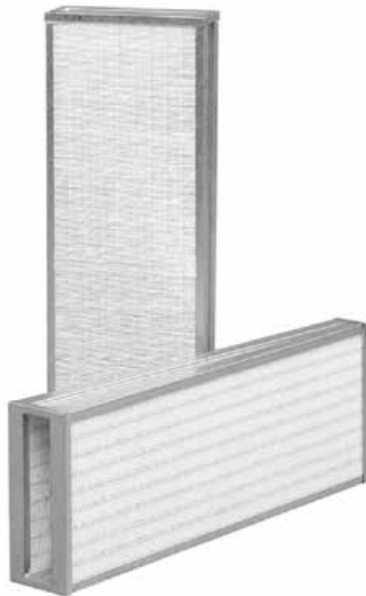

Type	N° Hifi	Dimensions / Abmessungen <i>mm</i>			Débit Flow Strom <i>m³/h</i>	ΔP initiale Initial ΔP Anfangs-ΔP <i>Pa</i>	Surface filtrante Filtering surface Filterierende Fläche <i>m²</i>	Cadre Frame Rahmen
		B	H	P				
E10								
1	NM 2311 S	202	87	600	200	150	3.50	Galva.
2	NM 2312 S	600	65	202	200	105	3.50	Galva.
1	NM 2374 S	303	87	600	300	190	4.73	Galva.
E12								
1	NM 2313 S	202	87	600	200	160	3.50	PVC
2	NM 2314 S	600	65	202	200	125	3.50	PVC
H13								
1	NM 2315 S	202	87	600	200	190	3.50	PVC
2	NM 2316 S	600	65	202	200	145	3.50	PVC
1	NM 2330 S	303	87	600	300	220	4.73	Galva.



Autres dimensions sur demande.
 Other dimensions on request.
 Andere Abmessungen auf Anfrage.

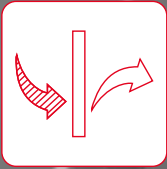

GAMME MOBILE

MOBILE PRODUCTS

PRODUKTE FÜR MOBILE GERÄTE

**Vous nous connaissez pour le matériel INDUSTRIE...
Cependant, avez-vous pensé à notre gamme MOBILE ?**

 Vous avez peut-être un ou plusieurs véhicules à moteur, 4 ou 2 roues, un bateau, du matériel d'entretien d'espaces verts, de manutention, de travaux publics, agricole... Nous pouvons vous apporter toutes les solutions complémentaires à vos approvisionnements en filtration. N'hésitez pas à nous consulter.

**You know about us because of our INDUSTRY range of products...
But have you ever thought about our MOBILE products?**

 We also offer a full range of supplementary filtration supplies for your 2- or 4-wheeled motor vehicle, boat, green space or public works maintenance or agricultural equipment. Please do not hesitate to contact us for further information.

**Sie kennen uns wegen unserer INDUSTRIE-produkte...
Haben Sie jedoch schon an unsere Produkte für MOBILE Geräte gedacht?**

 Sie besitzen vielleicht ein oder mehrere Motorfahrzeuge, 4 oder 2 Räder, ein Schiff, Geräte zur Pflege von Grünflächen, zur Beförderung, für öffentliche Bauarbeiten oder für die Landwirtschaft... Wir bieten Ihnen alle für Ihre Filterausrüstung erforderlichen Zusatzlösungen. Zögern Sie nicht, sich an uns zu wenden.



Travaux publics
Construction equipment
Hoch- und Tiefbau



Automobile
Passenger cars
PKW



Marine
Marine
Schifffahrt



Manutention
Handling equipment
Gabelstapler und Hebetchnik



Agricole
Agriculture
Landwirtschaft



Espaces verts
Golf & Parks
Golf und Gartentechnik



Poids lourds / Bus
Trucks / Buses
LKW / Busse



Remontées mécaniques
Ski lifts
Skipistenbearbeitung



Motos - Quads
Motorcycles - ATV
Motorräder - Quads

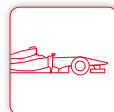

Hautes performances
High performance
Hochleistung



Vous souhaitez en savoir plus, nos équipes sont à votre écoute.
If you would like to know more, please contact one of our teams.
Für weitere Informationen wenden Sie sich bitte an unsere Mitarbeiter.

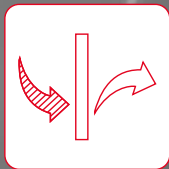

SOMMAIRE

CONTENTS

INHALTSVERZEICHNIS

ABC...

Codification

Codification
Legende

1 - 6

G

Préfiltre - Filtration gravimétrique

Prefilter - Gravimetric filtration
Vorfilter - Gravimetrische Filtrierung

7 - 28

F

Filtres fins - Filtration opacimétrique

Fine filter - Opacimetric filtration
Feinstaubfilter - Opazimetrische Filtrierung

29 - 48

H

Filtres absolus - Filtration absolue HEPA

Absolute filters - Absolute HEPA filtration
Schwebstoff-filter - HEPA Schwebstofffilter

49 - 64

CA
CAG

Adsorption - Filtres charbon actif

Adsorption - Carbon filters
Adsorbierung - Aktivkohle-Filteractive

65 - 68



Recommandations générales

General advices
Allgemeine Hinweise

Trucs et astuces

Tricks and clever bits
Tipps

Nos catalogues

Our catalogues
Unsere Kataloge

Conditions générales de vente

General terms of sales
Allgemeine Geschäftsbedingungen

69 - 80



CYLINDRES À CHARBON ACTIF
ACTIVECOAL CYLINDER
AKTIVKOHLE-ZYLINDER

Support / Support / Halt	Acier galvanisé ou inox / Galvanised steel or stainless steel / Stahl verzinkt oder Edelstahl
Température / Temperature / Temperatur	40°C max.
Humidité relative / Relative humidity / Luftfeuchtigkeit	70 % max.
Joint / Gasket / Dichtung	Neoprène / Neoprene / Neopren



N° Hifi	Support Support Halt	Dimensions Abmessungen mm		Type de charbon Coal type Kohletyp	Débit Flow Strom m³/h	ΔP initiale Initial ΔP Anfangs-ΔP Pa	Capacité de remplissage Filing capacity Füllmenge Kg
		Long. Lenght Länge	Epaisseur Thickness Dicke				
16 MM							
NC 711416 GG	Acier galvanisé Galvanised steel Stahl verzinkt	450	16	TK-A	212	100	1.40
NC 771416 GG	Acier galvanisé Galvanised steel Stahl verzinkt	600	16	TK-A	265	80	1.70
NC 711416 IG	Inox Stainless steel Edelstahl	450	16	TK-A	212	85	1.40
NC 771416 IG	Inox Stainless steel Edelstahl	600	16	TK-A	265	60	1.70
25 MM							
NC 081425 GG	Acier galvanisé Galvanised steel Stahl verzinkt	250	25	M2-3	85	82	1.70
NC 711425 GG	Acier galvanisé Galvanised steel Stahl verzinkt	450	25	M2-3	150	80	2.60
NC 711425 IG	Inox Stainless steel Edelstahl	450	25	M2-3	150	80	2.60
NC 771425 GG	Acier galvanisé Galvanised steel Stahl verzinkt	600	25	M2-3	205	75	3.50



Autres types de charbon sur demande
 Other types of carbonfilter on request
 Andere Kohlefiltertypen auf Anfrage



FILTRES À POCHE COMPACTES - CHARBON ACTIF
COMPACT POCKET FILTERS - CARBON ACTIVATED
KOMPAKT-TASCHENFILTER - AKTIVKOHLE

CAG - F7CA

Cadre / Frame / Rahmen	PVC
Profondeur des poches / Bag depth / Taschentiefe	292 mm
Média / Media / Media	Synthétique & charbon actif / Syntetic & activecoal / Syntetic & Aktivkohle
Classe de filtration / Class of filtration / Filterklasse	F7 (EN 779 : 2012)
Température / Temperature / Temperatur	65°C max.
Humidité relative / Relative humidity / Luftfeuchtigkeit	90 % max.
ΔP final recommended (F7CA)	600 Pa
Séparateurs / Separators / Trenner	Hotmelt



N° Hifi	Dimensions / Abmessungen <i>mm</i>			Débit Flow Strom <i>m³/h</i>	ΔP initiale Initial ΔP Anfangs-ΔP <i>Pa</i>	Surface filtrante Filtering surface Filterierende Fläche <i>m²</i>	Charbon actif Active carbon Aktivkohle <i>kg</i>
	L	I	P				
Charbon actif granulé / Granule activated carbon / Aktivkohlegranulat							
NM 535093DPCA	592	287	292	1200	150	-	6.5
NM 535263DPCA	592	492	292	200	150	-	9
NM 535353DPCA	592	592	292	400	150	-	13
F7 + charbon actif imprégné / F7 + Carbon activated impregnated / F7 + Aktivkohle imprägniert							
NM 535093DPF7CA	592	287	292	1600	120	4.3	-
NM 535263DPF7CA	592	492	292	2400	120	7.5	-
NM 535353DPF7CA	592	592	292	3200	120	9	-



Autres dimensions sur demande.
 Other dimensions on request.
 Andere Abmessungen auf Anfrage.

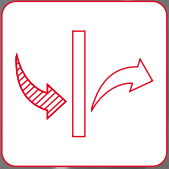

GAMME MOBILE

MOBILE PRODUCTS

PRODUKTE FÜR MOBILE GERÄTE

**Vous nous connaissez pour le matériel INDUSTRIE...
Cependant, avez-vous pensé à notre gamme MOBILE ?**

- Vous avez peut-être un ou plusieurs véhicules à moteur, 4 ou 2 roues, un bateau, du matériel d'entretien d'espaces verts, de manutention, de travaux publics, agricole... Nous pouvons vous apporter toutes les solutions complémentaires à vos approvisionnements en filtration. N'hésitez pas à nous consulter.

**You know about us because of our INDUSTRY range of products...
But have you ever thought about our MOBILE products?**

- We also offer a full range of supplementary filtration supplies for your 2- or 4-wheeled motor vehicle, boat, green space or public works maintenance or agricultural equipment. Please do not hesitate to contact us for further information.

**Sie kennen uns wegen unserer INDUSTRIE-produkte...
Haben Sie jedoch schon an unsere Produkte für MOBILE Geräte gedacht?**

- Sie besitzen vielleicht ein oder mehrere Motorfahrzeuge, 4 oder 2 Räder, ein Schiff, Geräte zur Pflege von Grünflächen, zur Beförderung, für öffentliche Bauarbeiten oder für die Landwirtschaft... Wir bieten Ihnen alle für Ihre Filterausrüstung erforderlichen Zusatzlösungen. Zögern Sie nicht, sich an uns zu wenden.



Travaux publics
Construction equipment
Hoch- und Tiefbau



Automobile
Passenger cars
PKW



Marine
Marine
Schifffahrt



Manutention
Handling equipment
Gabelstapler und Hebetchnik



Agricole
Agriculture
Landwirtschaft



Espaces verts
Golf & Parks
Golf und Gartentechnik



Poids lourds / Bus
Trucks / Buses
LKW / Busse



Remontées mécaniques
Ski lifts
Skipistenbearbeitung



Motos - Quads
Motorcycles - ATV
Motorräder - Quads

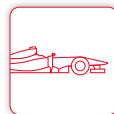

Hautes performances
High performance
Hochleistung



Vous souhaitez en savoir plus, nos équipes sont à votre écoute.
If you would like to know more, please contact one of our teams.
Für weitere Informationen wenden Sie sich bitte an unsere Mitarbeiter.

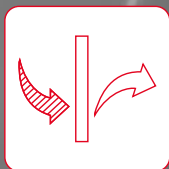

SOMMAIRE

CONTENTS

INHALTSVERZEICHNIS

ABC...

Codification

Codification
Legende

1 - 6

G

Préfiltre - Filtration gravimétrique

Prefilter - Gravimetric filtration
Vorfilter - Gravimetrische Filtrierung

7 - 28

F

Filtres fins - Filtration opacimétrique

Fine filter - Opacimetric filtration
Feinstaubfilter - Opazimetrische Filtrierung

29 - 48

H

Filtres absolus - Filtration absolue HEPA

Absolute filters - Absolute HEPA filtration
Schwebstoff-filter - HEPA Schwebstofffilter

49 - 64

CA
CAG

Adsorption - Filtres charbon actif

Adsorption - Carbon filters
Adsorbierung - Aktivkohle-Filteractive

65 - 68



Recommandations générales

General advices
Allgemeine Hinweise

Trucs et astuces

Tricks and clever bits
Tipps

Nos catalogues

Our catalogues
Unsere Kataloge

Conditions générales de vente

General terms of sales
Allgemeine Geschäftsbedingungen

69 - 80

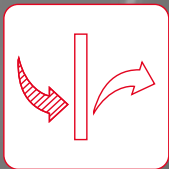

RECOMMANDATIONS GÉNÉRALES

GENERAL ADVICES

ALLGEMEINE ERKLÄRUNGEN

Recommandations générales

Les renseignements contenus dans ce catalogue sont diffusés à titre indicatif à notre clientèle et sont aussi exacts que possibles. Cependant, des erreurs d'impression ainsi que des modifications constructeurs peuvent apparaître après édition de ce document. En cas de doutes, nous vous prions de vous adresser à nous-mêmes ou à nos représentants. Tout nouveau catalogue annule les éditions précédentes. Toute reproduction, ne serait-ce que partielle, est interdite sans notre autorisation écrite.

General advices

All informations contained in this catalogue are given as an indication to our customers, and are as accurate as possible. Despite all our efforts, some printing mistakes can occur, as well as constructor modifications done after publication of this document. In case of doubts, please contact us or our sales representative directly. Every new catalogue supersedes previous editions. No part of this publication may be reproduced in any way without our prior written consent.

Allgemeine Erklärungen

Die Angaben in diesem Kataloge sind unverbindlich. Für Änderungen der Filterausrüstung durch die Fahrzeug- und Motorenhersteller oder durch die Hersteller von Filtererzeugnissen anderer Marken, übernehmen wir keinerlei Gewähr. Es können auch Druckfehler auftreten. In Zweifelsfällen bitten wir um Rückfrage bei uns, oder unseren Vertretern. Mit Erscheinen des neuesten Kataloges verlieren alle früheren Ausgaben ihre Gültigkeit. Für diese Unterlagen behalten wir uns alle Rechte vor. Nachdruck, auch auszugsweise, ist nur mit unserer vorherigen schriftlichen Genehmigung gestattet.

Recomendaciones generales

Informaciones dadas en este catálogo lo son a título de indicación y están tan exactas como posible y se ha puesto el máximo cuidado en su elaboración. Sin embargo, no se descarta la posibilidad de algún error de impresión, ni también los cambios que se practican a veces de parte de los fabricantes, posteriores a nuestra publicación. En caso de duda, le rogamos sirvanse llamarnos directamente con motivo de comprobarlo. Con cada nueva publicación, se pierden validez todas las ediciones anteriores. La reproducción total o parcial no está permitida sin nuestra previa autorización escrita.

Raccomandazioni generali

Le informazioni contenute in questo catalogo sono date a titolo indicativo ai nostri clienti e sono le più scrupolose possibili. Tuttavia alcuni errori di stampa o alcuni cambiamenti da parte dei costruttori possono apparire dopo la pubblicazione di questo documento. In caso di qualsiasi dubbio vogliate ulteriormente verificarlo con noi. Ad ogni nuova pubblicazione perdono validità le edizioni precedenti. Ristampe anche parziali non sono ammesse senza una nostra autorizzazione scritta.

Recomandări generale

Informațiile conținute în acest catalog sunt oferite clienților noștri cu titlu informativ și sunt cât se poate de exacte. Cu toate acestea, este posibil să apară erori de tipărire și modificări efectuate de constructori după editarea prezentului document. Dacă aveți îndoieli, vă rugăm să ne contactați pe noi sau pe reprezentanții noștri. Orice catalog nou anulează edițiile precedente. Orice reproducere, chiar și parțială, este interzisă fără autorizația noastră scrisă.

Zalecenia ogólne

Treści zawarte w niniejszym katalogu mają charakter informacyjny i są możliwie jak najdokładniejsze. Nie wyklucza się jednak błędów w druku lub zmian wprowadzonych przez producentów po publikacji niniejszego dokumentu. W razie wątpliwości prosimy o kontakt z nami lub naszymi przedstawicielami. Każdy nowy katalog unieważnia poprzednie edycje. Wszelkie powielanie, nawet częściowe, jest zabronione bez wcześniejszej pisemnej zgody z naszej strony.